



**ROYAL CANADIAN AIR CADETS
PROFICIENCY LEVEL FOUR
INSTRUCTIONAL GUIDE**



SECTION 1

EO M432.01 – DESCRIBE FUEL SYSTEMS

Total Time:	30 min
-------------	--------

PREPARATION

PRE-LESSON INSTRUCTIONS

Resources needed for the delivery of this lesson are listed in the lesson specification located in A-CR-CCP-804/PG-001, *Proficiency Level Four Qualification Standard and Plan*, Chapter 4. Specific uses for said resources are identified throughout the instructional guide within the TP for which they are required.

Review the lesson content and become familiar with the material prior to delivering the lesson.

Prepare slides located at Attachment A.

Photocopy the handout located at Attachment B for each cadet.

PRE-LESSON ASSIGNMENT

Nil.

APPROACH

An interactive lecture was chosen for this lesson to clarify, emphasize, and summarize fuel systems.

INTRODUCTION

REVIEW

Nil.

OBJECTIVES

By the end of this lesson the cadet shall have described fuel systems.

IMPORTANCE

It is important for cadets to be able to describe fuel systems as a solid understanding of fuel systems provides knowledge for potential instructional duties and is part of the fundamentals that cadets pursuing future aviation training will require.

Teaching Point 1**Describe fuel systems.**

Time: 10 min

Method: Interactive Lecture

THE FUEL SYSTEM

An aircraft fuel system stores and delivers the proper amount of fuel for all phases of flight, including:

- normal flight,
- violent manoeuvres,
- sudden acceleration, and
- sudden deceleration.

Fuel systems include the following parts:

- fuel tanks,
- a fuel selector valve,
- fuel lines and filters,
- a fuel quantity gauge, and
- fuel primer.

Pressure-Feed System

Show slide of Figure A-1 to the cadets.

Aircraft with low-wing configurations and large aircraft with a large volume of fuel movement use an engine-driven fuel pump to provide the pressure to keep fuel flowing. This system includes:

- the basic pump,
- auxiliary electric pumps for emergency situations,
- a booster pump to create the pressure required to start the fuel flowing before the engine is running, and
- the pressure gauge mounted on the cockpit panel used to read the pressure of fuel entering the carburetor.

Gravity-Feed System

Show slide of Figure A-2 to the cadets.

High-wing, low-powered light aircraft use the gravity-feed system. The bottom of the fuel tank in the wing must be high enough to provide pressure for the fuel to travel past the fuel selector to the carburetor.

Fuel Selector Valve

The fuel selector valve is used by the pilot to select the desired fuel tank to draw fuel. The selector valve may also be used to shut off the flow of fuel from the tanks.



A fuel selector valve can be operated manually or electrically depending of the installation.

FUEL

Aviation fuel has been specially formulated for use in aircraft. It is available in several different types / grades. The approved fuel types are specified in the pilot operating handbook.

Fuel Types

Fuel used in modern high compression engines must burn slowly and expand evenly rather than explode quickly (detonation). High octane fuels meet this requirement. The octane rating of fuels is calculated by the ratio of octane and heptane.

Octane. A substance which possesses minimum detonating qualities.

Heptane. A substance which possesses maximum detonating qualities.



Show slide of Figure A-3 to the cadets.



Proportion of octane to heptane is expressed as a percentage. For example 73 octane means 73 percent octane and 27 percent heptane.

Higher octane fuels are treated with sulphuric acid, lye, etc, used to remove the gum, acid, and other impurities.

Octane numbers can only go as high as 100. Beyond this, the performance number is the anti-knock value of the fuel for octane numbers above 100. Fuel grades are expressed by two performance numbers the first number indicates octane rating at lean mixture conditions, and the second number indicates octane rating at rich mixture condition.



Grade 100 / 130 indicates:

- lean mixture performance number of 100, and
- rich mixture performance number of 130.

CONFIRMATION OF TEACHING POINT 1

QUESTIONS:

- Q1. What fuel-feed system does an aircraft with low-wing configuration use?
- Q2. For what is the fuel selector valve used?
- Q3. How are octane ratings of fuels calculated?

ANTICIPATED ANSWERS:

- A1. An aircraft with low-wing configuration uses a pressure-feed system.
- A2. The fuel selector valve is used by the pilot to select the desired fuel tank to draw fuel. The selector valve may also be used to shut off the flow of fuel from the tanks.
- A3. Octane ratings of fuels are calculated as a ratio of octane and heptane.

Teaching Point 2

Describe carburetors.

Time: 10 min

Method: Interactive Lecture

CARBURETORS



Show slide of Figure A-4 to the cadets.

The heat energy in an internal combustion engine is developed from the burning of a mixture of gasoline and air. The carburetor measures the correct quantity of gasoline, vaporizes fuel, mixes it with the air in the required proportion and delivers the mixture to the cylinder when the combustion occurs.

An engine will run hotter with a lean mixture than a rich mixture as the lean mixture will burn slower and the cylinder walls are exposed to high heat for a longer time. A rich mixture burns quickly exposing the cylinder walls to high temperatures for a shorter time and the additional fuel in the fuel / air mix cools the engine.

The carburetor involves numerous complex devices to control the mixture ratio. Two types of carburetors used, include float carburetor, or pressure carburetor.

Float Carburetor



Show slide of Figure A-5 to the cadets.

Fuel flows through the fuel lines, enters the carburetor at the float valve and into the float chamber. A needle attached to the float, resting on the fuel within the chamber, opens and closes an opening at the bottom of the carburetor bowl. The float chamber is vented so the atmospheric and chamber pressure equalizes as the aircraft climbs and descends.

Air flows through an air filter usually located at an air intake in the front part of the engine cowling. The filtered air flows into the carburetor through a venturi (narrow throat in the carburetor). The air speed increases, creating a low pressure area which draws fuel at atmospheric pressure.

The air and vaporized fuel is regulated, in volume, by the throttle valve, enters the intake manifold and is distributed to the individual cylinders. The pilot is able to control the amount of fuel / air mixture from within the cockpit using the throttle control.



Forward movement of the throttle opens the throttle valve, which increases the fuel / air mixture, and increases the power being produced by the engine.

Aft movement of the throttle closes the throttle valve, which reduces the volume of fuel / air mixture, and decreases the power being produced by the engine.

Mixture Control



The correct fuel / air mixture will be obtained at sea level as carburetors are normally calibrated for sea level operation.

As altitude increases, the density of the air decreases and a given volume of air weighs less. The proportion of air by weight to that of fuel will become less although the volume remains the same. The mixture at higher altitude becomes over-rich causing fuel waste and loss of power.

A mixture control is fitted to the carburetor that adjusts the amount of fuel being drawn from the nozzle, restoring the proper fuel / air mix.

The general rules when using a manual mixture control are:

- rich mixtures—high power settings, and
- leaner mixtures—cruise power settings.

Carburetor Icing



Show slide of Figure A-6 to the cadets.

Distribute the handout located at Attachment B to each cadet.

With temperatures ranging from minus 5 degrees Celsius to plus 30 degrees Celsius and under certain moist atmospheric conditions, ice can form in the induction system closing off the flow of fuel to the engine. Ice can form on various surfaces of the carburetor especially on the throttle.



Show slide of Figure A-7 to the cadets.



Modern aircraft have incorporated a method of directing heated air into the carburetor air intake, activated by the carburetor hot air handle in the cockpit. This heated air can prevent ice from forming or melt ice that has already formed.

CONFIRMATION OF TEACHING POINT 2

QUESTIONS:

- Q1. How are the fuel / air proportions calculated?
- Q2. What does the mixture control adjust?
- Q3. What do modern aircraft have to melt ice that has formed?

ANTICIPATED ANSWERS:

- A1. Fuel / air proportions are calculated by weight not volume.
- A2. The mixture control adjusts the amount of fuel being drawn from the nozzle, restoring the proper fuel / air mix.
- A3. Modern aircraft have incorporated a method of directing heated air into the carburetor air intake, activated by the carburetor hot air handle in the cockpit.

Teaching Point 3

Describe fuel injection.

Time: 5 min

Method: Interactive Lecture

FUEL INJECTION

With a fuel injection system, a control valve supplies pressurized fuel continuously to the induction system near the intake valve. The fuel is vaporized and sucked into the cylinder during the intake stroke.

Advantages of fuel injection include:

- more uniform distribution of fuel to all cylinders,
- better cooling, through the elimination of lean hot mixtures to some of the more distant cylinders,
- fuel saving through uniform distribution,
- increased power since the heat carburetor air is eliminated, and
- elimination of the hazard of carburetor icing.



Throttle ice can occur when the temperature is less than 5 degrees Celsius. Impact ice can gather in bends in the system, impact tubes, and air filter.

CONFIRMATION OF TEACHING POINT 3**QUESTIONS:**

- Q1. What does the control valve do?
- Q2. What are the advantages of fuel injection?
- Q3. Where can impact ice gather?

ANTICIPATED ANSWERS:

- A1. The control valve supplies pressurized fuel continuously to the induction system near the intake valve.
- A2. Advantages of fuel injection include:
- more uniform distribution of fuel to all cylinders,
 - better cooling, through the elimination of lean hot mixtures to some of the more distant cylinders,
 - fuel saving through uniform distribution,
 - increased power since the heat carburetor air is eliminated, and
 - elimination of the hazard of carburetor icing
- A3. Impact ice can gather in the system, impact tubes, and air filter.

END OF LESSON CONFIRMATION**QUESTIONS:**

- Q1. What fuel-feed system does a high-wing, low-powered light aircraft use?
- Q2. Why is leaning the engine both practical and economical?
- Q3. When can throttle ice occur?

ANTICIPATED ANSWERS:

- A1. A high-wing, low-powered light aircraft uses a gravity-feed system.
- A2. It results in:
- better fuel economy lowering the cost of operation,
 - a smoother running engine,
 - a more efficient engine giving higher indicated airspeeds and better aircraft performance,
 - extended range of the aircraft at cruise,
 - less spark plug fouling and longer life for spark plugs,
 - more desirable engine temperatures, and
 - cleaner combustion chambers and less chance of pre-ignition from undesirable deposits.
- A3. Throttle ice can occur when the temperature is less than 5 degrees Celsius.

CONCLUSION

HOMEWORK / READING / PRACTICE

Nil.

METHOD OF EVALUATION

This EO is assessed IAW A-CR-CCP-804/PG-001, *Proficiency Level Four Qualification Standard and Plan*, Chapter 3, Annex B, Aviation Subjects–Combined Assessment PC.

CLOSING STATEMENT

Being able to describe fuel systems is important for understanding more complex material. A solid understanding of aero engines is required to pursue future aviation training.

INSTRUCTOR NOTES / REMARKS

Cadets who are qualified Advanced Aviation may assist with this instruction.

REFERENCES

C3-116 ISBN 0-9680390-5-7 MacDonald, A. F., & Pepler, I. L. (2000). *From the ground up: Millennium edition*. Ottawa, ON: Aviation Publishers Co. Limited.

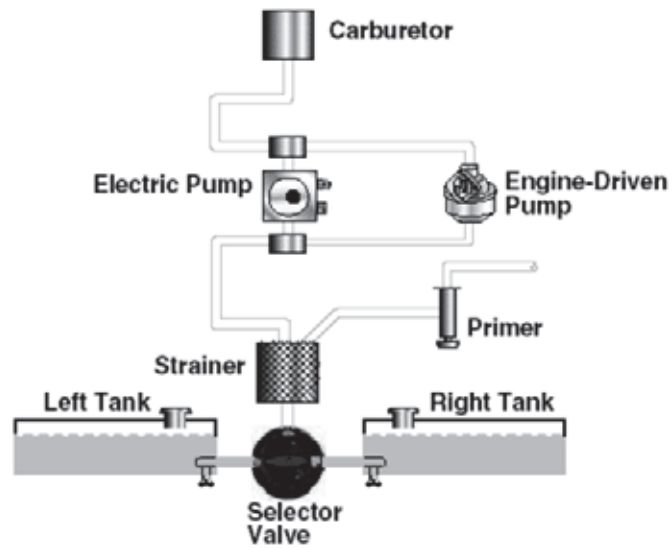

Figure A-1 Pressure-Feed System

Note. From "Online Free Private Pilot Ground School", *The Aircraft Powerplant*. Retrieved November 24, 2008, from <http://www.free-online-private-pilot-ground-school.com/aircraft-powerplant.html>

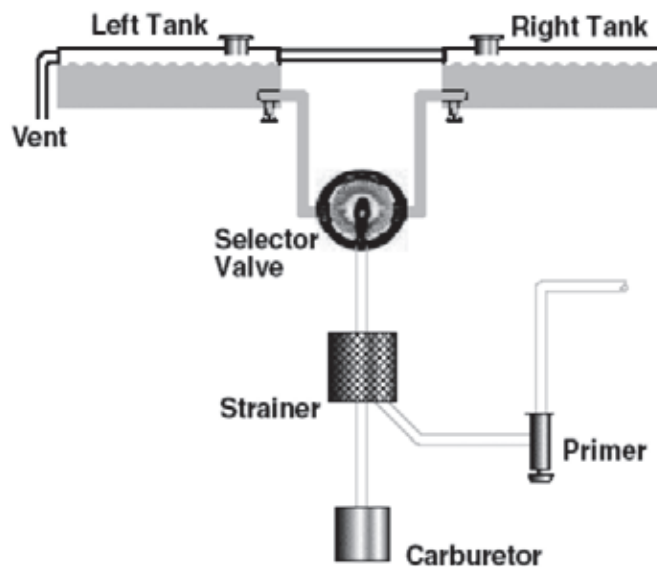

Figure A-2 Gravity-Feed System

Note. From "Online Free Private Pilot Ground School", *The Aircraft Powerplant*. Retrieved November 24, 2008, from <http://www.free-online-private-pilot-ground-school.com/aircraft-powerplant.html>





FUEL TYPE AND GRADE	COLOR OF FUEL	EQUIPMENT COLOR
AVGAS 80	RED	
AVGAS 100	GREEN	
AVGAS 100LL	BLUE	
JET A	COLORLESS OR STRAW	

Figure A-3 Fuel Types

Note. From "Online Free Private Pilot Ground School", *The Aircraft Powerplant*. Retrieved November 24, 2008, from <http://www.free-online-private-pilot-ground-school.com/aircraft-powerplant.html>

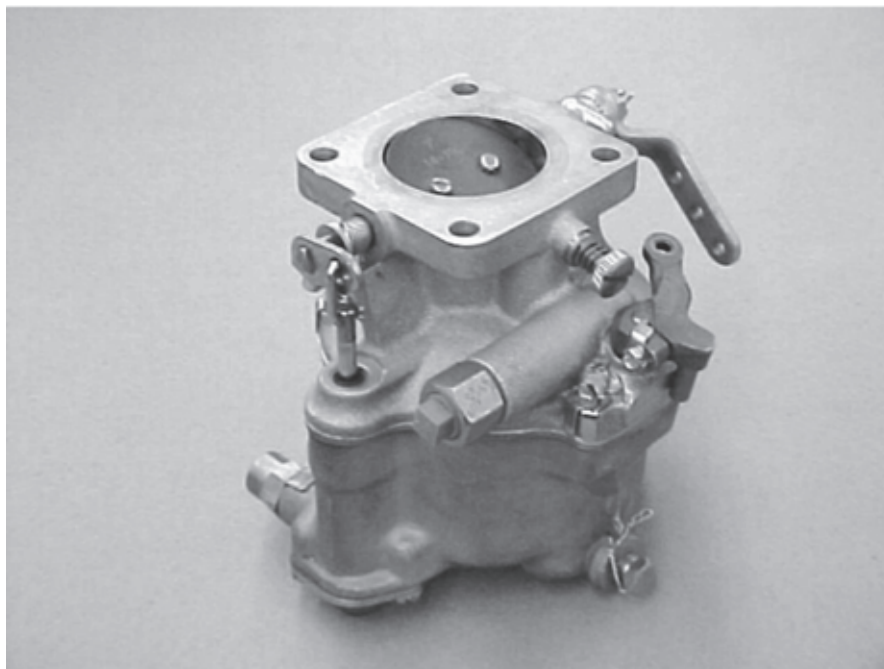

Figure A-4 Carburetor

Note. From "Online Free Private Pilot Ground School", *The Aircraft Powerplant*. Retrieved November 24, 2008, from <http://www.free-online-private-pilot-ground-school.com/aircraft-powerplant.html>

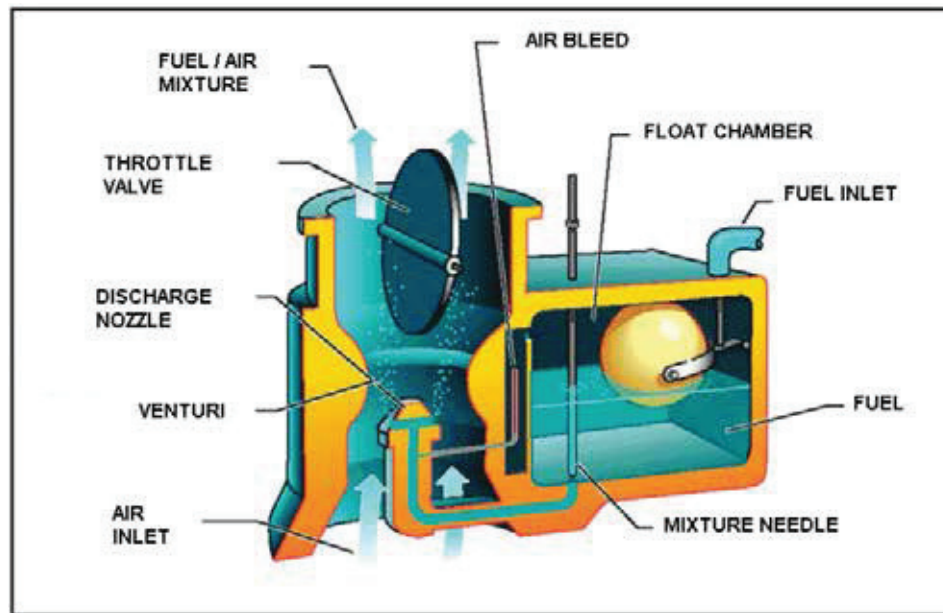

Figure A-5 Float-Type Carburetor

Note. From "Online Free Private Pilot Ground School", *The Aircraft Powerplant*. Retrieved November 26, 2008, from <http://www.free-online-private-pilot-ground-school.com/aircraft-powerplant.html>

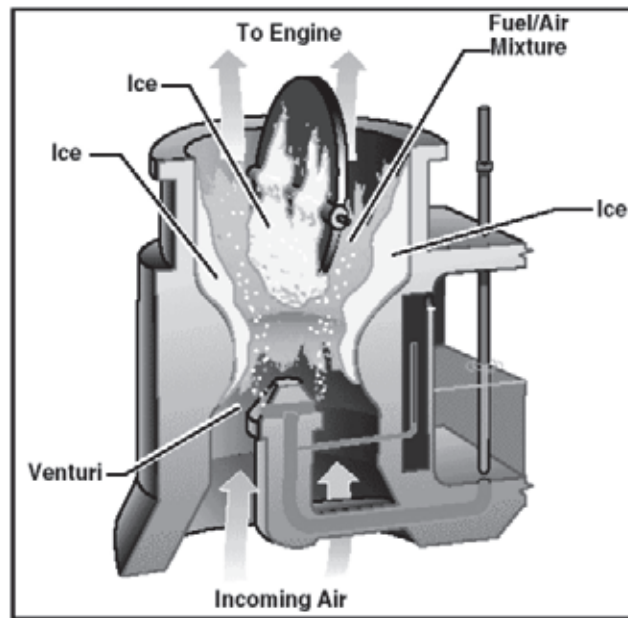

Figure A-6 Carburetor Icing

Note. From "Online Free Private Pilot Ground School", *The Aircraft Powerplant*. Retrieved November 26, 2008, from <http://www.free-online-private-pilot-ground-school.com/aircraft-powerplant.html>

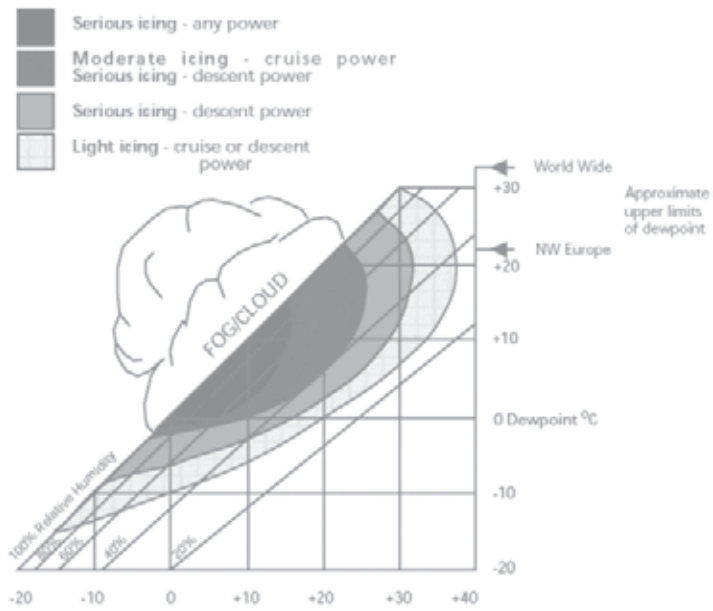

Figure A-7 Carburetor Icing Chart

Note. From "VAF Vansairforce.net", *The Truth about Carb Icing*, by J. Oldenkamp, 2006, Soonabe, FL. Retrieved November 27, 2008, from <http://www.vansairforce.com/community/showthread.php?t=9499>

CARBURETOR STUDY HANDOUT

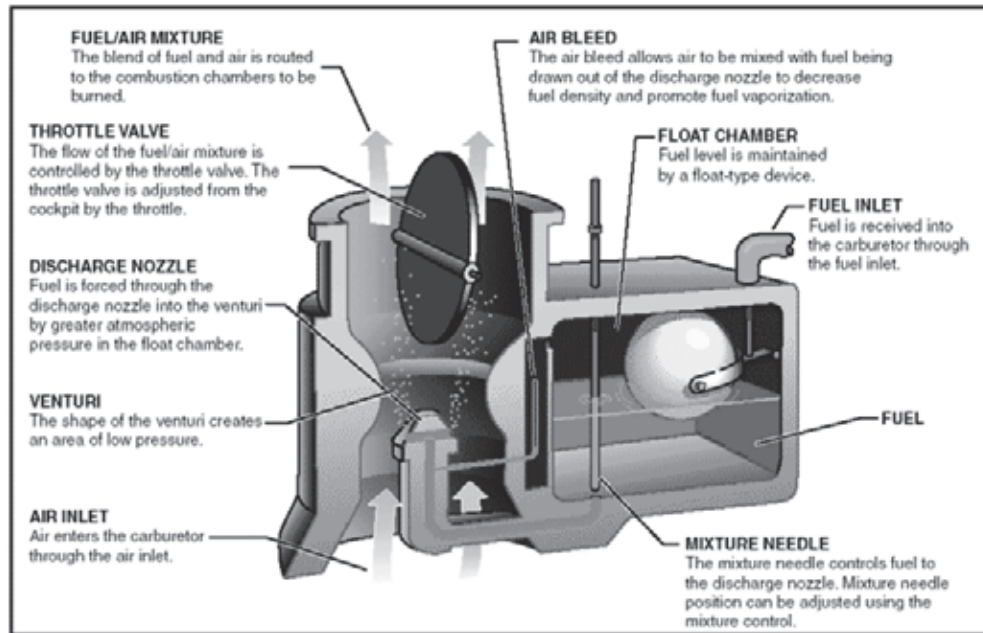

Figure B-1 Float-type Carburetor

Note. From "Online Free Private Pilot Ground School", *The Aircraft Powerplant*. Retrieved November 26, 2008, from <http://www.free-online-private-pilot-ground-school.com/aircraft-powerplant.html>

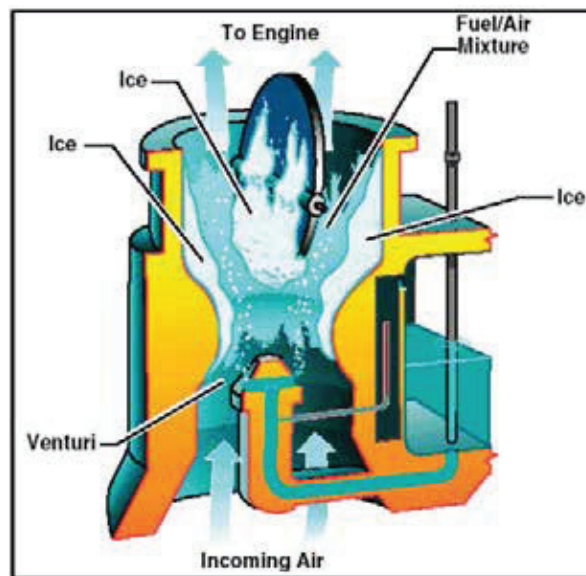

Figure B-2 Carburetor Icing

Note. From "Online Free Private Pilot Ground School", *The Aircraft Powerplant*. Retrieved November 26, 2008, from <http://www.free-online-private-pilot-ground-school.com/aircraft-powerplant.html>

THIS PAGE INTENTIONALLY LEFT BLANK



**ROYAL CANADIAN AIR CADETS
PROFICIENCY LEVEL FOUR
INSTRUCTIONAL GUIDE**



SECTION 2

EO M432.02 – DESCRIBE PROPELLER SYSTEMS

Total Time: 30 min

PREPARATION

PRE-LESSON INSTRUCTIONS

Resources needed for the delivery of this lesson are listed in the lesson specification located in A-CR-CCP-804/PG-001, *Proficiency Level Four Qualification Standard and Plan*, Chapter 4. Specific uses for said resources are identified throughout the instructional guide within the TP for which they are required.

Review the lesson content and become familiar with the material prior to delivering the lesson.

Prepare slides located at Attachment A.

PRE-LESSON ASSIGNMENT

Nil.

APPROACH

An interactive lecture was chosen for this lesson to clarify, emphasize, and summarize propeller systems.

INTRODUCTION

REVIEW

Nil.

OBJECTIVES

By the end of this lesson the cadet shall have described propeller systems.

IMPORTANCE

It is important for cadets to be able to describe propeller systems as a solid understanding of propeller systems provides knowledge for potential instructional duties and is part of the fundamentals that cadets pursuing future aviation training will require.

Teaching Point 1**Describe propeller systems.**

Time: 10 min

Method: Interactive Lecture

The propeller provides the necessary thrust to pull, or in some cases push, the airplane through the air. The engine power rotates the propeller that generates thrust very similar to the manner in which a wing produces lift.

The propeller is a rotating airfoil designed to push air backward as it moves forward along a corkscrew (helical) path. It meets the air at an angle of attack as it rotates, producing thrust (lift) and torque (drag).



Propeller torque is different than engine crankshaft torque in that propeller torque is drag. It is the resistance to the blades as they rotate, resulting in a tendency in the aircraft to roll in a direction opposite to the rotation of the propeller. Engine crankshaft torque is the turning moment produced at the crankshaft. When the propeller is revolving at a constant rpm, propeller torque and engine torque will be exactly equal and opposite.



Show slide of Figure A-1 to the cadets.

A typical propeller is twisted so the blade angles and tapers from the hub to the tip. The highest angle of incidence (pitch) is at the hub and the smallest pitch is at the tip.



Show slide of Figure A-2 to the cadets.

By means of the variation in airfoil sections and the angle of attack, uniform thrust is maintained throughout most of the diameter of the propeller.



Show slide of Figure A-3 to the cadets.



Tractors are propellers attached forward of the engine that pull from the front of the aircraft.
Pushers are propellers attached aft of the engine that push from behind the aircraft.

Pitch. The distance in feet a propeller travels forward in one revolution. Propeller pitch is the difference between theoretical pitch (geometric pitch) and practical pitch (effective pitch).

Theoretical pitch. The distance travelled forward in one revolution if the propeller was working in a perfect fluid. This depends on the blade angle and diameter of the propeller.

Practical pitch. The distance the propeller travels in air in one revolution. The forward motion is less than theoretical pitch.

The angle of the blade, like the angle of incidence of a wing, governs the pitch. The propeller set in coarse pitch will travel a greater distance with each revolution. The aircraft will move forward at greater speed for a given rpm.

The propeller set in fine pitch will have less torque (drag) and will revolve at a higher speed around its axis. The engine will produce greater power. A fine pitch propeller will be good for taking off and climbing but a coarse pitch propeller will develop high cruise speed with comparatively low engine rpm giving good fuel economy.

CONFIRMATION OF TEACHING POINT 1

QUESTIONS:

- Q1. What does the propeller provide?
- Q2. What is propeller torque?
- Q3. For what is a fine pitch propeller good?

ANTICIPATED ANSWERS:

- A1. The propeller provides the necessary thrust to pull, or in some cases push, the airplane through the air.
- A2. It is the resistance to the blades as they rotate, resulting in a tendency in the aircraft to roll in a direction opposite to the rotation of the propeller.
- A3. A fine pitch propeller will be good for taking off and climbing.

Teaching Point 2

Describe types of propellers.

Time: 10 min

Method: Interactive Lecture

FIXED PITCH PROPELLERS

Fixed pitch propeller. The blade angle can not be adjusted by the pilot and is used on most training aircraft. The blade angle is set by the manufacturer to provide the best compromise for all flight conditions.

VARIABLE PITCH PROPELLERS

Adjustable pitch propeller. The blade angle can be changed on the ground to adjust for the varying flight situations such as changed takeoff and climb needs.

Controllable pitch propeller. The blade angles can be adjusted by the pilot during flight. The propeller set in a fine pitch for takeoff allows the engine to develop maximum power. The propeller is then adjusted to a coarse pitch to accelerate at a rapid rate to the desired cruise speed.

Constant speed propeller. The blade angles automatically adjust themselves to maintain a constant rpm as set by the pilot.

The mechanism for adjusting the pitch of the propeller includes:

- mechanical,
- hydraulic, and
- electrical.

Mechanical variable pitch propeller. The pilot adjusts this type of propeller by a control on the instrument panel. The control is directly linked to the propeller which has stop sets to govern the blade angle and travel.

Hydraulic variable pitch propellers. A hydraulically operated cylinder pushes or pulls on a cam connected to gears on the propeller blade. The mechanism can be a counterweight or hydromatic.

The counterweight relies on oil pressure to move the cylinder that twists the blades of a controllable pitch propeller toward fine pitch. The control is adjusted by the pilot in the cockpit.

A constant pitch propeller uses the oil pressure and counterweight principle to twist the blades to the proper pitch angle to maintain a constant rpm. The pilot uses the throttle and propeller control located in the cockpit. The throttle controls the power output of the engine and the propeller control regulates the rpm of both the propeller and the engine.



If oil pressure is lost during flight, the propeller will automatically go into an extreme coarse pitch position where the blades are streamlined and cease to turn (feathered). This system is used in multi-engine aircraft.

A powerful force called centrifugal twisting moment turns the blades toward the fine pitch position of a hydromatic constant speed propeller. The natural force eliminates the use of counterweights. Oil enters the piston chamber under high pressure which moves the piston aft and the blades move into coarse pitch. When the oil enters into the piston chamber under engine pressure, the blades move to fine pitch.



If oil pressure is lost during flight, the propeller will automatically go into fine pitch position, enabling the engine to develop the most power it can and achieve the best performance under the circumstances. This system is used in single-engine aircraft.

Electric variable pitch propellers. An electrical motor turns the blades through a gear speed reducer and bevel gears for an electrical variable pitch propeller. Flyweights open and close electric circuits. One circuit causes a right-hand rotation of the motor and another causes a left-hand rotation. The rotation of the motor will adjust the blades toward a fine or coarse pitch as required. The pilot can set a two-way switch to either manual or automatic operation.

CONFIRMATION OF TEACHING POINT 2

QUESTIONS:

- Q1. Who sets the blade angle on fixed pitch propeller?
- Q2. How can the propeller pitch be adjusted?
- Q3. What happens to the propeller if oil pressure is lost on a single-engine aircraft?

ANTICIPATED ANSWERS:

- A1. The blade angle is set by the manufacturer.
- A2. The mechanism for adjusting the pitch of the propeller includes:
 - mechanical,
 - hydraulic, and
 - electrical.
- A3. If oil pressure is lost during flight, the propeller will automatically go into fine pitch position, enabling the engine to develop the most power it can and achieve the best performance under the circumstances.

Teaching Point 3**Describe feathering and propeller reversing.**

Time: 5 min

Method: Interactive Lecture

Feathering is used on multi-engine aircraft. When one engine is off, the propeller is feathered meaning the turning blades are the extreme coarse pitch position and stop turning. This reduces drag on the blades, possible damage to the defective engine and stops excessive vibration.

Propeller reversing is used at slow speed to assist with stopping an aircraft once on the ground. The blade angle of a controllable pitch propeller is changed to a negative value. The reverse pitch uses engine power to produce a high negative thrust at slow speed.



A pilot of a multi-engine aircraft can decrease the radius of a turn by using propeller reversing with the inside engine.

CONFIRMATION OF TEACHING POINT 3**QUESTIONS:**

- Q1. What is feathering?
- Q2. For what is propeller reversing used?
- Q3. What pitch angle is used during propeller reversing?

ANTICIPATED ANSWERS:

- A1. Feathering is when blades are set to the extreme coarse pitch position and stop turning.
- A2. Propeller reversing is used at slow speed to assist with stopping an aircraft once on the ground.
- A3. A negative pitch angle is used during propeller reversing.

END OF LESSON CONFIRMATION**QUESTIONS:**

- Q1. What is pitch?
- Q2. Name two propeller types.
- Q3. What type of aircraft use propeller feathering?

ANTICIPATED ANSWERS:

- A1. Pitch is the distance in feet a propeller travels forward in one revolution.
- A2. Fixed pitch and variable pitch.
- A3. Multi-engine aircraft.

CONCLUSION

HOMEWORK / READING / PRACTICE

Nil.

METHOD OF EVALUATION

This EO is assessed IAW A-CR-CCP-804/PG-001, *Proficiency Level Four Qualification Standard and Plan*, Chapter 3, Annex B, Aviation Subjects–Combined Assessment PC.

CLOSING STATEMENT

Being able to describe propeller systems is important for understanding more complex material. A solid understanding of propellers is required to pursue future aviation training.

INSTRUCTOR NOTES / REMARKS

Nil.

REFERENCES

C3-116 ISBN 0-9680390-5-7 MacDonald, A. F., & Pepler, I. L. (2000). *From the ground up: Millennium edition*. Ottawa, ON: Aviation Publishers Co. Limited.

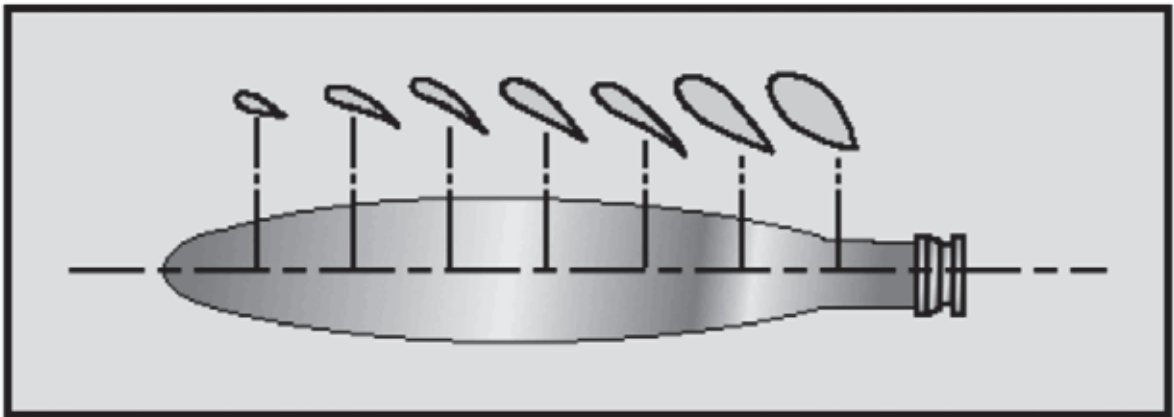

Figure A-1 Propeller Blade Shape

Note. From "Online Free Private Pilot Ground School", *The Aircraft Powerplant*. Retrieved November 27, 2008, from <http://www.free-online-private-pilot-ground-school.com/aircraft-powerplant.html>

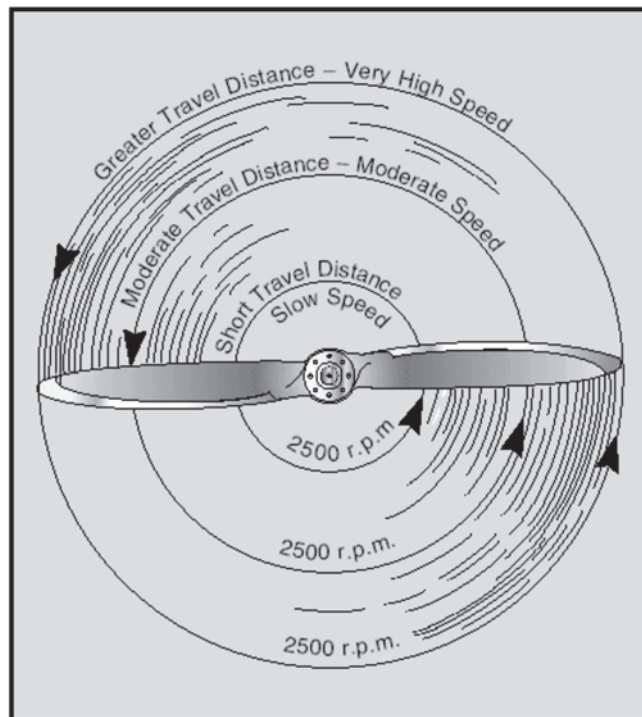

Figure A-2 Relationship of Travel Distance and Speed of Various Portions of Propeller Blade

Note. From "Online Free Private Pilot Ground School", *The Aircraft Powerplant*. Retrieved November 27, 2008, from <http://www.free-online-private-pilot-ground-school.com/aircraft-powerplant.html>

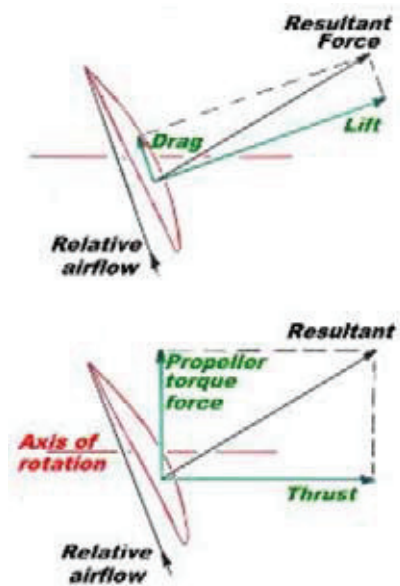

Figure A-3 Forces Acting on a Propeller Blade

Note. From "Recreational Aviation Australia Incorporated", *Engine and Propeller Performance*.
Retrieved March 12, 2009, from <http://www.auf.asn.au/groundschool/propeller.html>



**ROYAL CANADIAN AIR CADETS
PROFICIENCY LEVEL FOUR
INSTRUCTIONAL GUIDE**



SECTION 3

EO M432.03 – DESCRIBE ENGINE INSTRUMENTS

Total Time:	30 min
-------------	--------

PREPARATION

PRE-LESSON INSTRUCTIONS

Resources needed for the delivery of this lesson are listed in the lesson specification located in A-CR-CCP-804/PG-001, *Proficiency Level Four Qualification Standard and Plan*, Chapter 4. Specific uses for said resources are identified throughout the instructional guide within the TP for which they are required.

Review the lesson content and become familiar with the material prior to delivering the lesson.

Prepare slides located at Attachment A.

Photocopy the Aero Engines Review Worksheet located at Attachment B for each cadet.

PRE-LESSON ASSIGNMENT

Nil.

APPROACH

An interactive lecture was chosen for TPs 1–4 to clarify, emphasize, and summarize engine instruments.

An in-class activity was chosen for TP 5 as it is an interactive way to reinforce the topic and confirm the cadets' comprehension of aero engine systems.

INTRODUCTION

REVIEW

Nil.

OBJECTIVES

By the end of this lesson the cadet shall have described engine instruments.

IMPORTANCE

It is important for cadets to be able to describe engine instruments as a solid understanding of engine instruments provides knowledge for potential instructional duties and is part of the fundamentals that cadets pursuing future aviation training will require.

Teaching Point 1**Describe the oil pressure and oil temperature gauges.**

Time: 5 min

Method: Interactive Lecture



Show slide of Figure A-1 to the cadets.

One of the principle engine instruments is the oil pressure gauge. It is usually positioned beside the oil temperature and fuel gauges. The instrument is calibrated in pounds per square inch (psi) and indicates the oil pressure supplied by the oil pump to lubricate the engine.

The gauge should be checked immediately after the engine has been started. As the oil warms, the reading should adjust to operational pressure. This may take up to 15 minutes. If the pressure remains high, the engine is not getting proper lubrication. High oil pressure pushes oil into the combustion chamber where it burns causing a smoky exhaust and badly carbonized piston heads, valve seats, cylinder heads and more.

Low oil pressure causes more serious problems as no film of oil goes between the working surfaces of the engine. Metal against metal rubbing causes main bearings to wear out.

The oil temperature gauge records the temperature of the oil in degrees Fahrenheit or Celsius. As the oil warms during start-up, the pressure should read high and the temperature low. Both instruments should approach their normal readings as the oil warms.



An abnormal drop in oil pressure and rise in oil temperature indicates trouble. Also, no change in oil pressure but a change in oil temperature is a warning of excessive friction or overload in the engine.

CONFIRMATION OF TEACHING POINT 1**QUESTIONS:**

- Q1. Which two gauges measure the properties of the engine oil?
- Q2. When should the oil pressure gauge be first checked?
- Q3. What changes in oil pressure and temperature indicates trouble?

ANTICIPATED ANSWERS:

- A1. Oil pressure and temperature gauges.
- A2. Immediately after the engine has been started.
- A3. An abnormal drop in oil pressure and rise in oil temperature.

Teaching Point 2**Describe the cylinder head temperature gauge.**

Time: 5 min

Method: Interactive Lecture



Show slide of Figure A-2 to the cadets.

The cylinder head temperature gauge shows the temperature of one or all engine cylinder heads. This reading shows the pilot the effectiveness of the engine cooling system. Extremely high cylinder head temperatures indicate an immediate sign of engine overload which can result in detonation, pre-ignition, and eventual engine failure.



Detonation. Abnormally rapid combustion due to the inability of fuel to burn slowly. Detonation is dangerous and expensive, causing high stress on engine parts and overheating.

Pre-ignition. The premature ignition of the mixture due to glowing carbon particles. It is sometimes confused with detonation. Pre-ignition is often experienced when attempting to start a hot engine and results in a backfire.

CONFIRMATION OF TEACHING POINT 2**QUESTIONS:**

- Q1. Which gauge measures the effectiveness of the engine cooling system?
- Q2. What do extremely high cylinder head temperatures indicate?
- Q3. In what can engine overload result?

ANTICIPATED ANSWERS:

- A1. The cylinder head temperature gauge.
- A2. An immediate engine overload.
- A3. Detonation, pre-ignition and eventual engine failure.

Teaching Point 3**Describe the tachometer.**

Time: 5 min

Method: Interactive Lecture



Show slide of Figure A-3 to the cadets.

The tachometer shows the speed at which the engine crankshaft is turning in hundreds of revolutions per minute (rpm). The tachometer records the engine hours of operation. The more common types of tachometer, are mechanical including centrifugal, or magnetic and electrical, which include direct current, or alternating current.

An aircraft with a fixed pitch propeller will only have a tachometer to read the engine power produced. It records the rpm at which the engine cranks and the propeller turns.

An aircraft with a controllable pitch or a constant speed propeller uses two gauges. The tachometer shows the rpm settings as controlled by the propeller control. The manifold pressure gauge shows the power produced by the engine.

The tachometer is marked with colour-coded arcs to indicate the proper range of engine operation, including:

- green indicating normal range of operation;
- yellow indicating the caution range and possible problems; and
- red indicating the maximum limit.

CONFIRMATION OF TEACHING POINT 3

QUESTIONS:

- Q1. What does the tachometer show?
- Q2. How is the tachometer marked?
- Q3. Which colours are used to indicate the proper range of engine operation?

ANTICIPATED ANSWERS:

- A1. The speed at which the engine crankshaft is turning.
- A2. With colour-coded arcs.
- A3. Green (normal range), yellow (caution range), and red (maximum limit).

Teaching Point 4

Describe the manifold pressure gauge.

Time: 5 min

Method: Interactive Lecture



Show slide of Figure A-4 to the cadets.

The manifold pressure gauge also has colour-coded arcs displayed on the gauge to indicate the normal operating range and operation limits. The gauge indicates in inches of mercury the fuel / air pressure in the engine intake manifold at the point between the carburetor and the cylinders.

With an aircraft fitted with a constant speed propeller, the rpm setting will remain constant. The manifold pressure gauge is the only instrument to show any fluctuations in the engine power output. A reduction in manifold pressure can indicate carburetor icing.

When the engine is not running, the reading on the manifold pressure gauge will be of the existing atmospheric pressure.

Excessive manifold pressure raises the compression pressure causing high stress on the pistons and cylinder assemblies. It also produces excessive temperature which may cause scoring on the pistons, sticking rings, and burned out valves.



When increasing power, increase the rpm first and then the manifold pressure.

When decreasing power, decrease the manifold pressure first and then the rpm.

CONFIRMATION OF TEACHING POINT 4

QUESTIONS:

- Q1. What does the manifold pressure gauge indicate?
- Q2. What can a reduction in manifold pressure indicate?
- Q3. What will the reading on the manifold pressure gauge be when the engine is not running?

ANTICIPATED ANSWERS:

- A1. The gauge indicates in inches of mercury the fuel / air pressure in the engine intake manifold at the point between the carburetor and the cylinders.
- A2. Carburetor icing.
- A3. The existing atmospheric pressure.

Teaching Point 5

Conduct an in-class activity to review aero engines.

Time: 5 min

Method: In-Class Activity

OBJECTIVE

The objective of this activity is to have the cadets review aero engine systems.

RESOURCES

- Pen / pencil,
- Aero Engines Review Worksheet located at Attachment B, and
- Aero Engines Review Worksheet Answer Key located at Attachment C.

ACTIVITY LAYOUT

Nil.

ACTIVITY INSTRUCTIONS

1. Distribute a worksheet to each cadet.
2. Have the cadets complete the worksheet.
3. When the cadets have completed their worksheet, have them review their answers using the answer key located at Attachment C.

SAFETY

Nil.

CONFIRMATION OF TEACHING POINT 5

The cadets' participation in the activity will serve as the confirmation of this TP.

END OF LESSON CONFIRMATION

The cadets' completion of the Aero Engines Review Worksheet will serve as the confirmation of this lesson.

CONCLUSION

HOMEWORK / READING / PRACTICE

Additional time may be required for the cadets to complete the worksheet.

METHOD OF EVALUATION

This EO is assessed IAW A-CR-CCP-804/PG-001, *Proficiency Level Four Qualification Standard and Plan*, Chapter 3, Annex B, Aviation Subjects–Combined Assessment PC.

CLOSING STATEMENT

Being able to describe engine instruments is important for understanding more complex material. A solid understanding of engine instruments is required to pursue future aviation training.

INSTRUCTOR NOTES / REMARKS

Nil.

REFERENCES

C3-116 ISBN 0-9680390-5-7 MacDonald, A. F., & Pepler, I. L. (2000). *From the ground up: Millennium edition*. Ottawa, ON: Aviation Publishers Co. Limited.



Oil Pressure Gauge



Oil Temperature Gauge

Figure A-1 Oil Pressure and Temperature Gauges

Note. From *From the Ground Up* (p. 133), by A. F. MacDonald and I. L. Pepper, 2000, Ottawa, ON: Aviation Publishers Co. Limited. Copyright 2000 by Aviation Publishers Co. Limited.

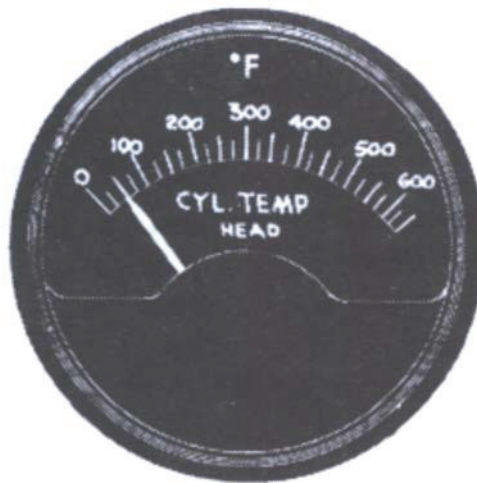

Figure A-2 Cylinder Head Temperature Gauge

Note. From *From the Ground Up* (p. 133), by A. F. MacDonald and I. L. Pepper, 2000, Ottawa, ON: Aviation Publishers Co. Limited. Copyright 2000 by Aviation Publishers Co. Limited.

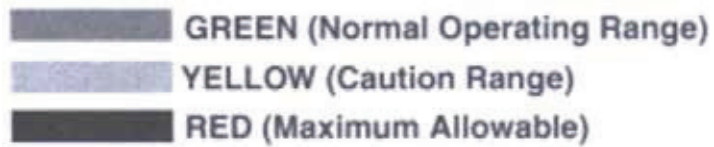
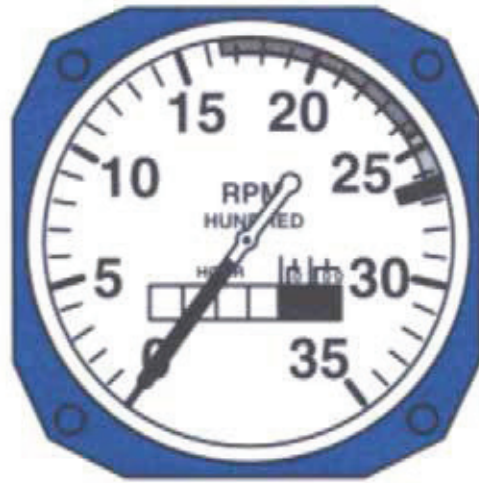

Figure A-3 Tachometer

Note. From *From the Ground Up* (p. 133), by A. F. MacDonald and I. L. Pepper, 2000, Ottawa, ON: Aviation Publishers Co. Limited. Copyright 2000 by Aviation Publishers Co. Limited.



Figure A-4 Manifold Pressure Gauge

Note. From *From the Ground Up* (p. 133), by A. F. MacDonald and I. L. Pepper, 2000, Ottawa, ON: Aviation Publishers Co. Limited. Copyright 2000 by Aviation Publishers Co. Limited.

Aero Engines Review Worksheet

1. Where should the fuel tank be positioned in a gravity feed system?
_____.
2. What system do low-wing configured aircraft and large aircraft with a large volume of fuel use?
_____.
3. What does the fuel selector valve, used by the pilot, do?
_____.
4. A rich mixture is used for:
_____.
5. How are the fuel / air proportions calculated?
_____.
6. Which propeller would not be good for taking off and climbing?
_____.
7. What is maintained throughout most of the diameter of the propeller by means of the variation in airfoil sections and the angle of attack?
_____.
8. What is the distance a propeller travels forward in one revolution?
_____.
9. What colour-coded arcs are found on the tachometer?
_____.
10. What reading will register on the manifold pressure gauge when the engine is not running?
_____.
11. What occurs to an engine as the altitude increases and the air becomes less?
_____.
12. A feathered propeller is in:
_____.
13. In what units is the oil pressure gauge calibrated?
_____.
14. What does the tachometer show?
_____.

15. Label the following parts on the diagram below.

- a. Thrust
- b. Relative airflow
- c. Propeller
- d. Axis of rotation
- e. Propeller torque force

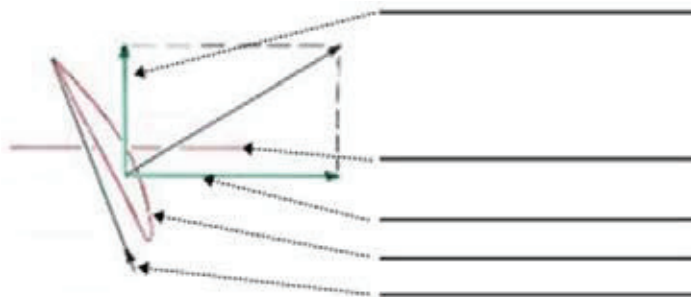

Aero Engines Review Worksheet Answer Key

1. Where should the fuel tank be positioned in a gravity feed system?
Above the carburetor.
2. What system do low-wing configured aircraft and large aircraft with a large volume of fuel use?
Pressure-feed system.
3. What does the fuel selector valve, used by the pilot, do?
Select desired fuel tank to draw fuel and shut off the flow of fuel from the tanks.
4. A rich mixture is used for:
high power settings.
5. How are the fuel / air proportions calculated?
By volume.
6. Which propeller would not be good for taking off and climbing?
Coarse pitch.
7. What is maintained throughout most of the diameter of the propeller by means of the variation in airfoil sections and the angle of attack?
Thrust.
8. What is the distance a propeller travels forward in one revolution?
Pitch.
9. What colour-coded arcs are found on the tachometer?
Green, yellow, red.
10. What reading will register on the manifold pressure gauge when the engine is not running?
Atmospheric pressure.
11. What occurs to an engine as the altitude increases and the air becomes less dense?
Power decreases.
12. A feathered propeller is in:
extreme coarse pitch position and stops turning.
13. In what units is the oil pressure gauge calibrated?
Pounds per square inch.
14. What does the tachometer show?
The speed at which the engine crankshaft is turning.

15. Label the following parts on the diagram below.

- a. Thrust
- b. Relative airflow
- c. Propeller
- d. Axis of rotation
- e. Propeller torque force

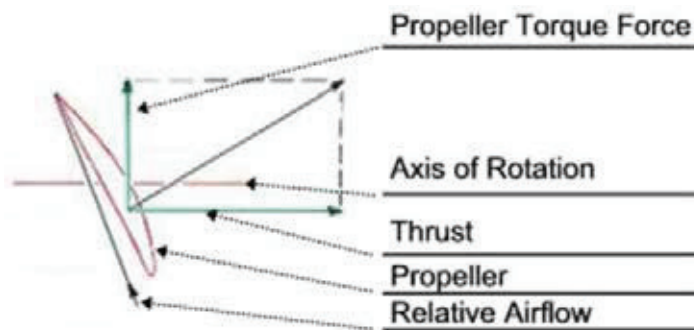



**ROYAL CANADIAN AIR CADETS
PROFICIENCY LEVEL FOUR
INSTRUCTIONAL GUIDE**



SECTION 4

EO C432.01 – DESCRIBE IGNITION AND ELECTRICAL SYSTEMS

Total Time:	30 min
-------------	--------

PREPARATION

PRE-LESSON INSTRUCTIONS

Resources needed for the delivery of this lesson are listed in the lesson specification located in A-CR-CCP-804/PG-001, *Proficiency Level Four Qualification Standard and Plan*, Chapter 4. Specific uses for said resources are identified throughout the instructional guide within the TP for which they are required.

Review the lesson content and become familiar with the material prior to delivering the lesson.

Prepare slides located at Attachment A.

PRE-LESSON ASSIGNMENT

Nil.

APPROACH

An interactive lecture was chosen for this lesson to clarify, emphasize, and summarize the ignition and electrical systems.

INTRODUCTION

REVIEW

Nil.

OBJECTIVES

By the end of this lesson the cadet shall have described ignition and electrical systems.

IMPORTANCE

It is important for cadets to be able to describe ignition and electrical systems as a solid understanding of ignition and electrical systems provides knowledge for potential instructional duties and is part of the fundamentals that cadets pursuing future aviation training will require.

Teaching Point 1**Describe the ignition system.**

Time: 15 min

Method: Interactive Lecture



Show slide of Figure A-1 to the cadets.

The ignition system provides an electrical spark to ignite the fuel / air mixture in each cylinder. The system usually consists of:

- two magnetos,
- two spark plugs per cylinder,
- ignition leads, and
- a magneto switch (on the instrument panel).

The magneto is an engine-driven generator which produces an electrical current without using an external current. It combines all elements of the ignition system, including:

- generating a low tension current;
- transforming the low tension current to high tension; and
- distributing the current to the individual spark plugs and causing them to fire.

When the magneto switch is off, the system is grounded and the electrical charge does not flow through the magneto and a spark is not produced. When the switch is on, the system is not grounded and the electrical charge flows through the magneto and a spark can be produced.

Dual ignition systems include two spark plugs in each cylinder, and two magnetos.

One spark plug in each cylinder is fired by one magneto. The other magneto fires the second spark plug in each cylinder. This dual ignition system provides improved:

- **Safety.** If one system fails, the engine will still operate.
- **Performance.** Improved combustion of the fuel / air mixture increases the power output and gives better engine performance.

The magneto switch allows the pilot to select either one or both magneto systems. The engine should always be operated on both magneto systems during takeoff and normal flight.



The magneto switch shall be turned to off when the aircraft is parked. If the propeller is moved, the engine can fire if the ignition switch is on.

Correctly set ignition timing allows the magneto to fire at the right time. If the spark plug fires too early, poor engine performance may occur, including:

- loss of power, and
- overheating which can lead to:
 - detonation,
 - pre-ignition,
 - piston burning,
 - scored cylinders, and
 - broken rings.

The wires in the ignition system are shielded (a metal covering which is grounded). Shielding prevents the ignition current from interfering with the radio, whole ignition system, magnetos, plugs, and wiring.

CONFIRMATION OF TEACHING POINT 1

QUESTIONS:

- Q1. What are the parts of the ignition system?
- Q2. What does correct set ignition timing allow?
- Q3. What does shielding prevent?

ANTICIPATED ANSWERS:

- A1. The ignition system has:
- two magnetos,
 - two spark plugs per cylinder,
 - ignition leads, and
 - a magneto switch (on the instrument panel).
- A2. Allows the magneto to fire at the right time.
- A3. The ignition current from interfering with the radio, whole ignition system, magnetos, plugs, and wiring.

Teaching Point 2

Describe the electrical system.

Time: 10 min

Method: Interactive Lecture



Show slide of Figure A-2 to the cadets.

The electrical system includes everything that operates electrically except the magnetos. There is no connection from the aircraft's electrical system to the ignition system.

The basic electrical system includes:

- a storage battery,
- master switch and battery solenoid,
- starter motor and solenoid,
- generator (or alternator),
- voltage regulator,
- bus bar, and
- circuit breakers.

The electrical system is either a 12- or 24-volt system and is direct current. The battery solenoid activated by the master switch completes the circuit between the electrical energy from the storage battery and the electrical system. The most important action by a pilot is to have the battery fully charged for the electrical components to function satisfactorily.

The starter switch activates the starter solenoid which allows current to enter and drive the starter motor.

The engine drives the generator or alternator for the purpose of providing current to the electrical system, and recharging the battery.



An alternator produces sufficient current to operate the various electrical components at low engine speeds.

A generator will not begin to supply current until the engine is turning at a faster speed.

The voltage regulator is used to prevent the generator or alternator from overloading the system, and the battery from becoming overcharged.

The current produced by the generator or alternator and battery is received by the bus bar which passes the current through the various circuit breakers and branches out to the various electrical circuits.

Circuit breakers or other fuses protect all electrical circuits from damage from excess voltage or current, and short-circuits. Most circuit breakers have a push button to reset. If the circuit breaker continues to fail, there may be malfunction in the component that could cause an electrical fire.

The pilot monitors the electrical system in the cockpit using:

- an ammeter,
- a voltmeter, and / or
- a warning light.

The ammeter measures in amperes the rate of flow of the electrical current being produced and when power is being used by the battery.

The voltmeter indicates the voltage in the electrical system.

The generator warning light shows when the generator is not working.



If the ammeter is showing on the plus (+) side of 0 on the gauge, there is satisfactory electrical operation.

If the ammeter is showing discharge or minus (-), energy is drawing from the battery rather than from the generator / alternator.

All contacts between the battery, voltage regulator, and the alternator or generator need to be clean and secure. Battery water level should be checked regularly and an aged battery that is no longer working properly should immediately be replaced.

CONFIRMATION OF TEACHING POINT 2

QUESTIONS:

- Q1. What is the most important action by a pilot regarding the electrical system?
- Q2. What instruments does the pilot monitor?
- Q3. What do all the contacts between the battery, voltage regulator, and the alternator or generator need to be?

ANTICIPATED ANSWERS:

- A1. Ensure the battery is fully charged.
- A2. An ammeter, a voltmeter, and / or a warning light.
- A3. To be clean and secure.

END OF LESSON CONFIRMATION

QUESTIONS:

- Q1. What is the difference between an alternator and a generator?
- Q2. What shall the magneto switch be turned to when the aircraft is parked?
- Q3. What is included in the basic electrical system?

ANTICIPATED ANSWERS:

- A1. An alternator produces sufficient current to operate the various electrical components at low engine speeds while a generator will not begin to supply current until the engine is turning at a faster speed.
- A2. The magneto switch shall be turned to off when the aircraft is parked.
- A3. The basic system includes:
- a storage battery,
 - master switch and battery solenoid,
 - starter motor and solenoid,
 - generator (or alternator),
 - voltage regulator,

- bus bar, and
- circuit breakers.

CONCLUSION

HOMEWORK / READING / PRACTICE

Nil.

METHOD OF EVALUATION

Nil.

CLOSING STATEMENT

Being able to describe ignition and electrical systems is important for understanding more complex material. A solid understanding of ignition and electrical systems is required to pursue future aviation training.

INSTRUCTOR NOTES / REMARKS

Cadets who are qualified Advanced Aviation may assist with this instruction.

REFERENCES

C3-116 ISBN 0-9680390-5-7 MacDonald, A. F., & Peppler, I. L. (2000). *From the ground up: Millennium edition*. Ottawa, ON: Aviation Publishers Co. Limited.

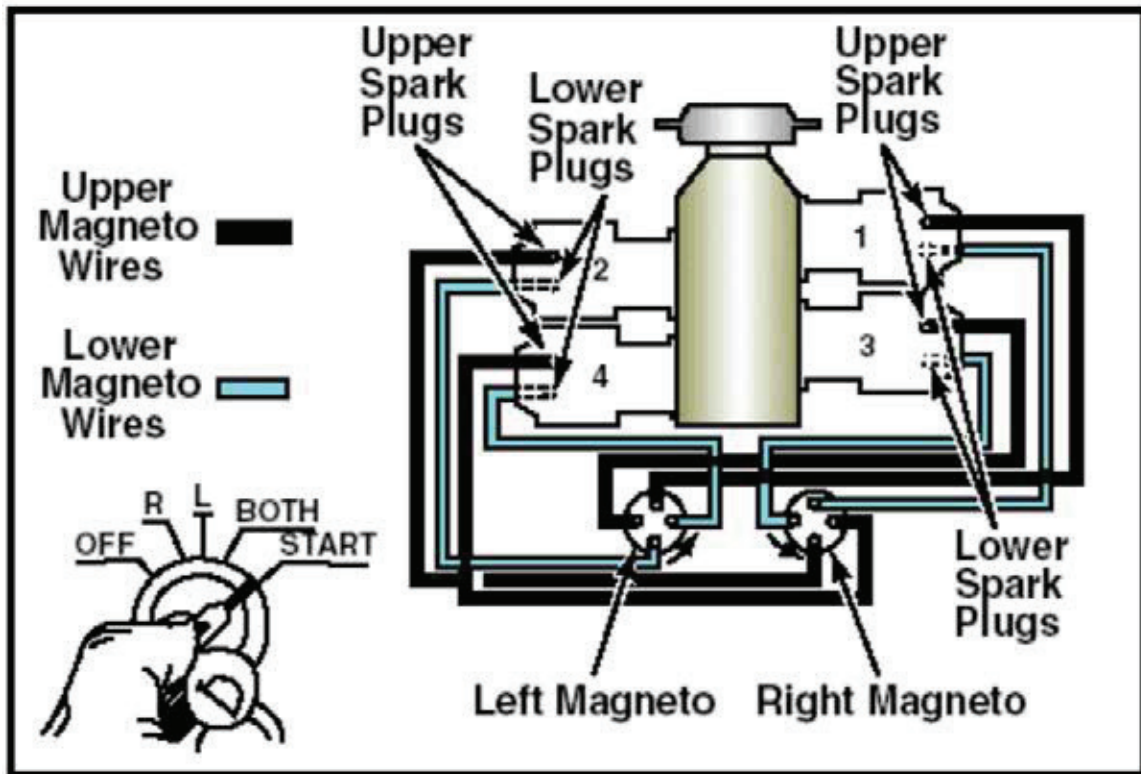

Figure A-1 Ignition System

Note. From "Online Free Private Pilot Ground School", *The Aircraft Powerplant*. Retrieved March 13, 2009, from <http://www.free-online-private-pilot-ground-school.com/aircraft-powerplant.html>

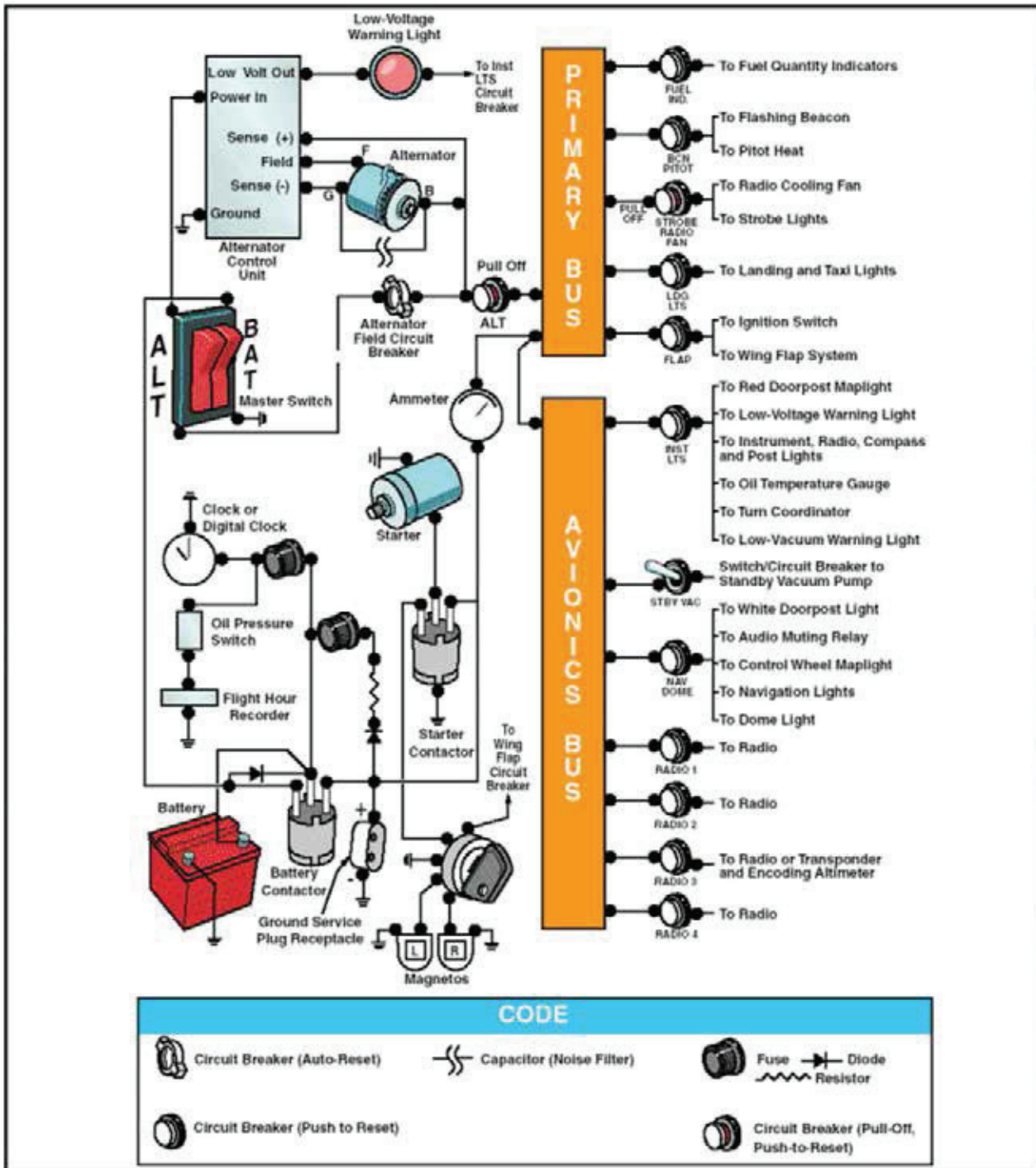

Figure A-2 Electrical System

Note. From "Online Free Private Pilot Ground School", *The Aircraft Powerplant*. Retrieved March 13, 2009, from <http://www.free-online-private-pilot-ground-school.com/aircraft-powerplant.html>



ROYAL CANADIAN AIR CADETS
PROFICIENCY LEVEL FOUR
INSTRUCTIONAL GUIDE



SECTION 5

EO C432.02 – DESCRIBE TURBOCHARGING AND SUPERCHARGING SYSTEMS

Total Time:	30 min
-------------	--------

PREPARATION

PRE-LESSON INSTRUCTIONS

Resources needed for the delivery of this lesson are listed in the lesson specification located in A-CR-CCP-804/PG-001, *Proficiency Level Four Qualification Standard and Plan*, Chapter 4. Specific uses for said resources are identified throughout the instructional guide within the TP for which they are required.

Review the lesson content and become familiar with the material prior to delivering the lesson.

Prepare slides located at Attachment A.

Photocopy the Turbocharging and Supercharging Worksheet located at Attachment B for each cadet.

PRE-LESSON ASSIGNMENT

Nil.

APPROACH

An interactive lecture was chosen for TPs 1 and 2 to clarify, emphasize, and summarize turbocharging and supercharging systems.

An in-class activity was chosen for TP 3 to confirm the cadets' comprehension of turbocharging and supercharging.

INTRODUCTION

REVIEW

Nil.

OBJECTIVES

By the end of this lesson the cadet shall have described turbocharging and supercharging systems.

IMPORTANCE

It is important for cadets to be able to describe turbocharging and supercharging systems as a solid understanding of turbocharging and supercharging systems provides knowledge for potential instructional duties and is part of the fundamentals that cadets pursuing future aviation training will require.

Teaching Point 1**Describe turbocharging.**

Time: 10 min

Method: Interactive Lecture



Show slide of Figure A-1 to the cadets.

The capability of the engine to produce power decreases as altitude increases and the air becomes less dense. A turbocharger supplies dense air when the aircraft is operating in thin air at a high altitude using the engine power without using engine horsepower.



Show slide of Figure A-2 to the cadets.

Hot exhaust gases are discharged as waste energy and directed through a turbine wheel (impeller) at high rpm. The turbine wheel is mounted on a shaft paired with a centrifugal air compressor enclosed in separate housings. The compressor turns at the same speed as the turbine wheel. The air supplied by the compressor will be denser which enables the engine to produce more power.

The turbocharger is located between the air intake and the carburetor so the air is compressed before mixing with the fuel from the carburetor. The speed of the turbine depends on the difference in pressure between the exhaust gas and the outside pressure. The greater the difference, the less back pressure on the escaping gases and more speed by the turbine.

When flying at lower, denser altitudes, a waste gate in the exhaust system can remain open and the exhaust gas vents around the turbine into the atmosphere. Control of the turbocharger is provided by manual control, and automatic control.

Manual control. The simplest control system. It involves bleeding exhaust gas continuously through an opening of predetermined size allowing the remainder of the exhaust gas to turn the turbocharger. Engine power is adjusted by the throttle.

The more common manual control connects the throttle and the waste gate with the cockpit throttle control. A programmed movement of the throttle plate in the carburetor and the waste gate pair the opening and closing of the two systems. As the throttle plate moves toward full open, the waste gate closes.

Automatic control. A pressure controller senses the difference in air pressure and controls the position of the waste gate using pressurized oil.

The turbocharging system increases performance at altitude. It delivers full power at altitudes above the service ceiling of a normal engine.

CONFIRMATION OF TEACHING POINT 1
QUESTIONS:

- Q1. What does a turbocharger supply?
- Q2. On what does the speed of the turbine depend?
- Q3. What does the pressure controller in an automatic control do when it senses a difference in air pressure?

ANTICIPATED ANSWERS:

- A1. Dense air when the aircraft is operating in thin air at a high altitude.
- A2. The difference in pressure between the exhaust gas and the outside pressure.
- A3. It controls the position of the waste gate using pressurized oil.

Teaching Point 2
Describe supercharging systems.

Time: 5 min

Method: Interactive Lecture



Show slide of Figure A-3 to the cadets.

Supercharging works on the same general principles as turbocharging (eg, density). The supercharger is an internally driven compressor powered by the engine. A supercharger compresses the fuel / air mixture after it leaves the carburetor (forced induction). When forced induction is used to increase the power of an engine at low altitudes, it is called boost.

When forced induction is used at high altitude to adjust for the lower density of the air and maintain sea level power, it is called supercharging.



Turbocharging. Compressing the intake air using a turbine turned by the exhaust gases.

Supercharging. Compressing the intake air using a turbine turned by the engine / crankshaft power.

CONFIRMATION OF TEACHING POINT 2
QUESTIONS:

- Q1. What powers the supercharger?
- Q2. What is the name given when the supercharger compresses the fuel / air mixture after it leaves the carburetor?
- Q3. What is supercharging?

ANTICIPATED ANSWERS:

- A1. The engine powers the supercharger.
- A2. Forced induction.
- A3. Supercharging is the use of forced induction at high altitude to adjust for the lower density of the air and maintain sea level power.

Teaching Point 3

Conduct an in-class activity to confirm the cadets' comprehension of turbocharging and supercharging.

Time: 10 min

Method: In-Class Activity

OBJECTIVE

The objective of this activity is to have the cadets confirm their comprehension of turbocharging and supercharging.

RESOURCES

- Pen / pencil,
- Turbocharging and Supercharging Worksheet located at Attachment B, and
- Turbocharging and Supercharging Worksheet Answer Key located at Attachment C.

ACTIVITY LAYOUT

Nil.

ACTIVITY INSTRUCTIONS

1. Distribute a worksheet to each cadet.
2. Have the cadets complete the worksheet.
3. Review the answers using the answer key.

SAFETY

Nil.

CONFIRMATION OF TEACHING POINT 3

The cadets' participation in the activity will serve as the confirmation of this TP.

END OF LESSON CONFIRMATION

The cadets' completion of the Turbocharging and Supercharging Worksheet will serve as the confirmation of this lesson.

CONCLUSION

HOMEWORK / READING / PRACTICE

Nil.

METHOD OF EVALUATION

Nil.

CLOSING STATEMENT

Being able to describe turbocharging and supercharging systems is important for understanding more complex material. A solid understanding of turbocharging and supercharging systems is required to pursue future aviation training.

INSTRUCTOR NOTES / REMARKS

Cadets who are qualified Advanced Aviation may assist with this instruction.

REFERENCES

C3-116 ISBN 0-9680390-5-7 MacDonald, A. F., & Pepler, I. L. (2000). *From the ground up: Millennium edition*. Ottawa, ON: Aviation Publishers Co. Limited.

THIS PAGE INTENTIONALLY LEFT BLANK

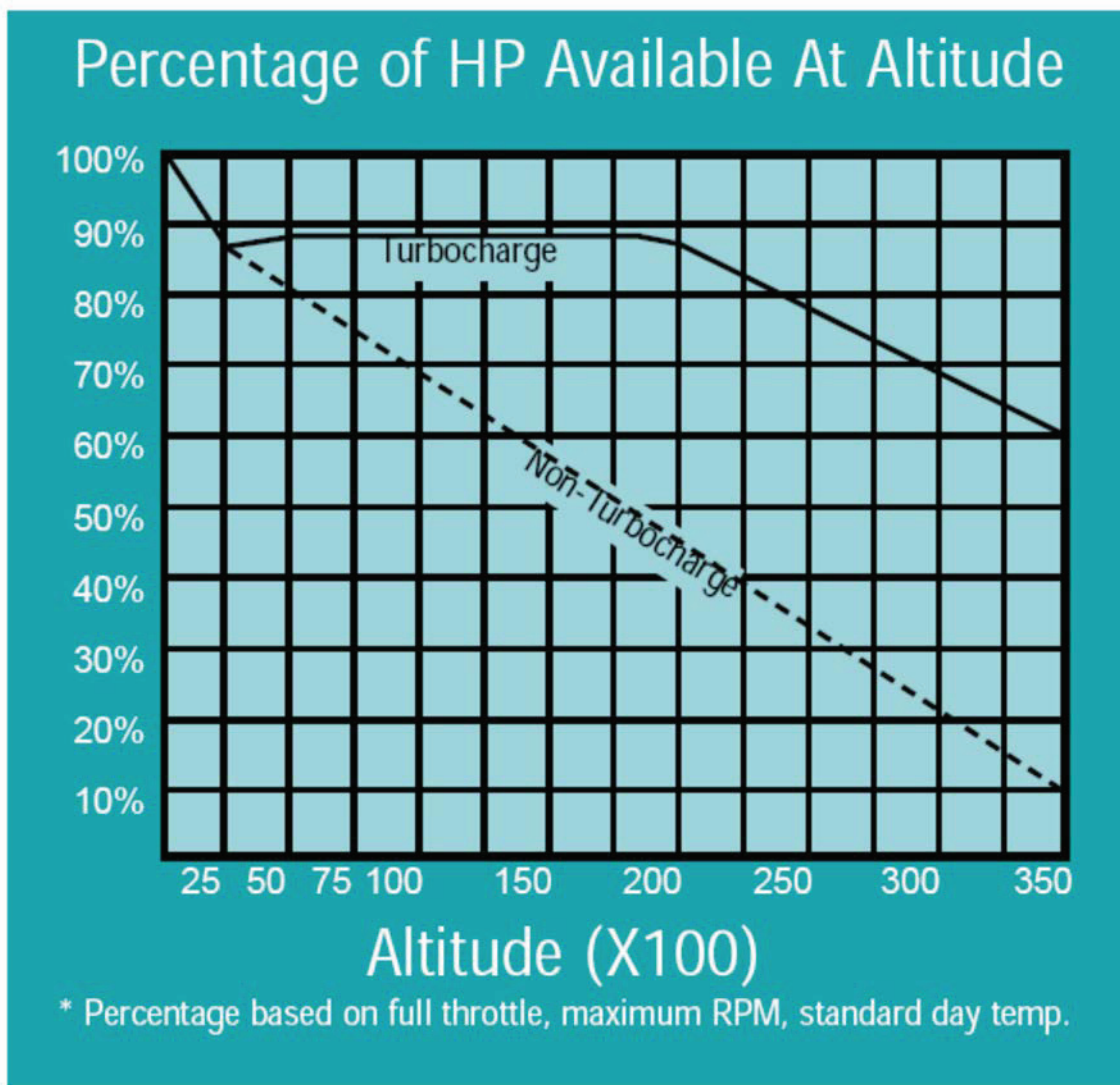

Figure A-1 Percentage of Horsepower Available at Altitude

Note. From "Boosting Your Knowledge of Turbocharging", *Kelly Aerospace*. Retrieved March 17, 2009, from <http://www.kellyaerospace.com/articles/Turbocharging.pdf>

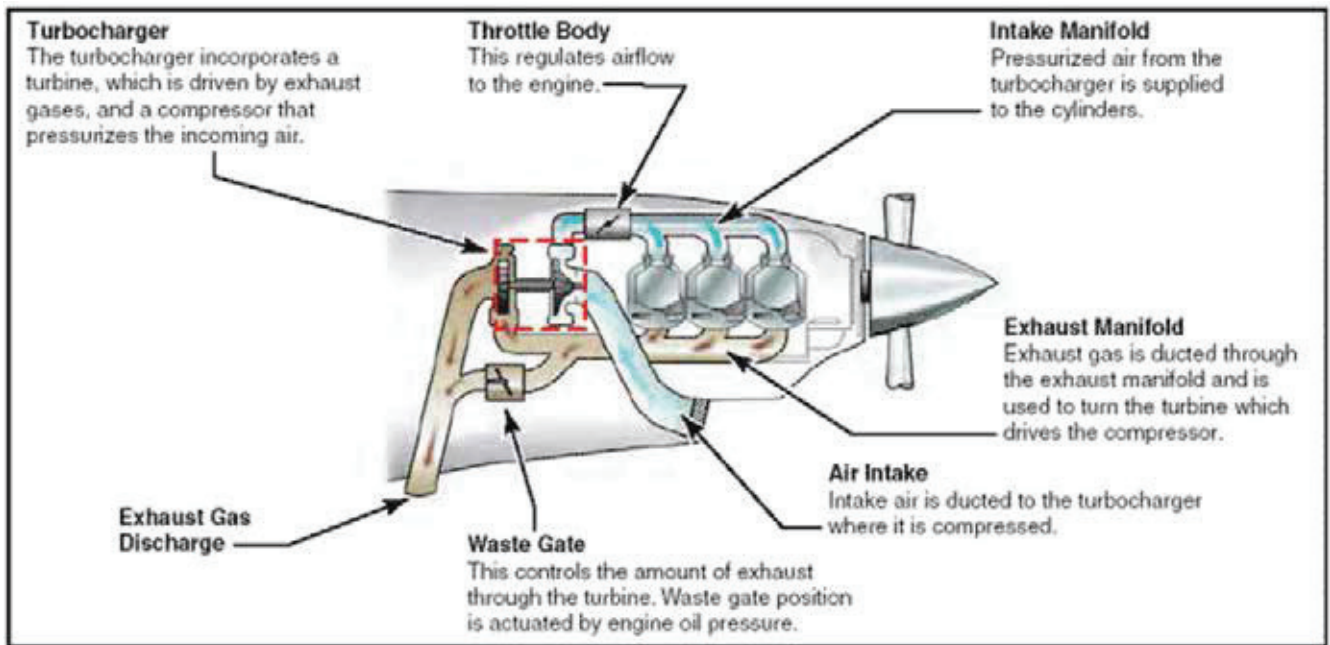

Figure A-2 Turbocharger Components

Note. From "Online Free Private Pilot Ground School", *The Aircraft Powerplant*. Retrieved March 17, 2009, from <http://www.free-online-private-pilot-ground-school.com/aircraft-powerplant.html>

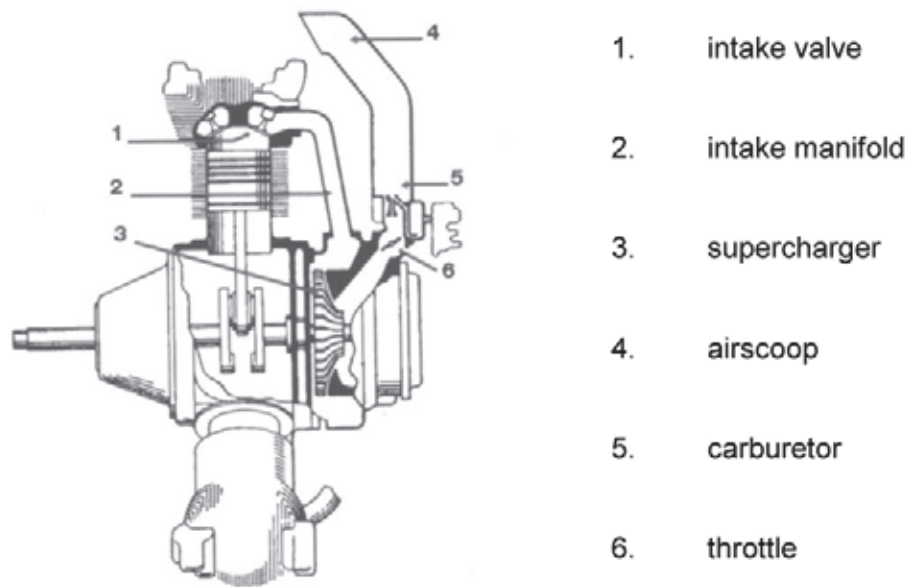

Figure A-3 Supercharger Components

Note. From *From the Ground Up: Millennium Edition* (p. 56), by A. F. MacDonald and I. L. Pepper, 2000, Ottawa, ON: Aviation Publishers Co. Limited. Copyright 2000 by Aviation Publishers Co. Limited.

Turbocharging and Supercharging Worksheet

1. Place the following labels in the correct location:
 - a. exhaust manifold,
 - b. air intake,
 - c. waste gate,
 - d. exhaust gas discharge,
 - e. turbocharger,
 - f. throttle body, and
 - g. intake manifold.

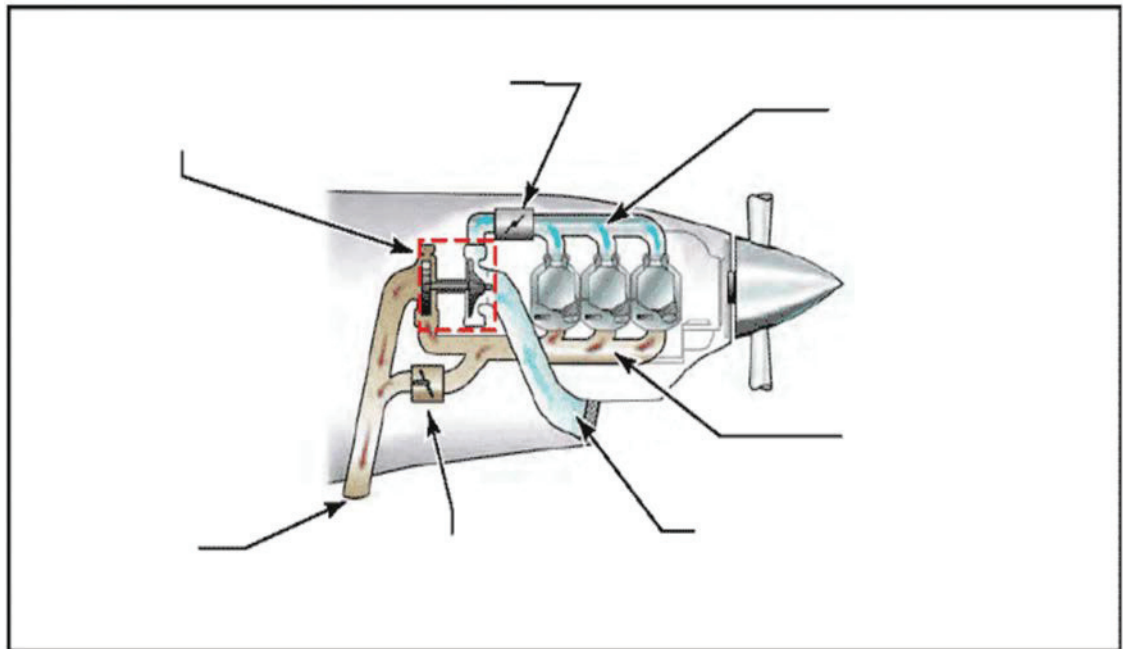

Figure B-1 Turbocharger Components

Note. From "Online Free Private Pilot Ground School", *The Aircraft Powerplant*. Retrieved March 17, 2009, from <http://www.free-online-private-pilot-ground-school.com/aircraft-powerplant.html>

2. Explain the key differences between turbocharging and supercharging.

3. Place the following labels in the correct location:

- a. supercharger,
- b. intake manifold,
- c. airscoop,
- d. intake valve,
- e. carburetor, and
- f. throttle.

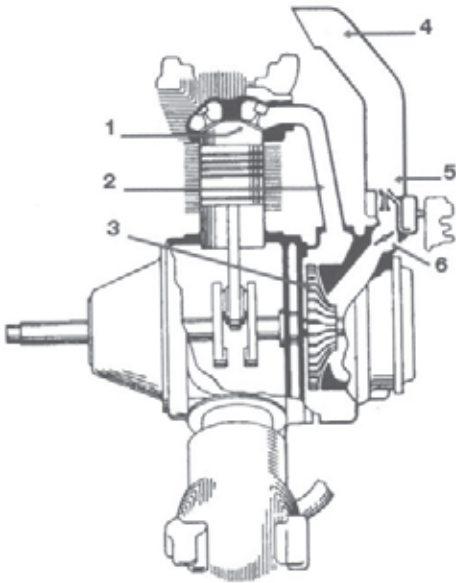

- 1. _____
- 2. _____
- 3. _____
- 4. _____
- 5. _____
- 6. _____

Figure B-2 Supercharger Components

Note. From *From the Ground Up: Millennium Edition* (p. 56), by A. F. MacDonald and I. L. Pepper, 2000, Ottawa, ON: Aviation Publishers Co. Limited. Copyright 2000 by Aviation Publishers Co. Limited.

Turbocharging and Supercharging Worksheet Answer Key

1. Place the following labels in the correct location:
 - a. exhaust manifold,
 - b. air intake,
 - c. waste gate,
 - d. exhaust gas discharge,
 - e. turbocharger,
 - f. throttle body, and
 - g. intake manifold.

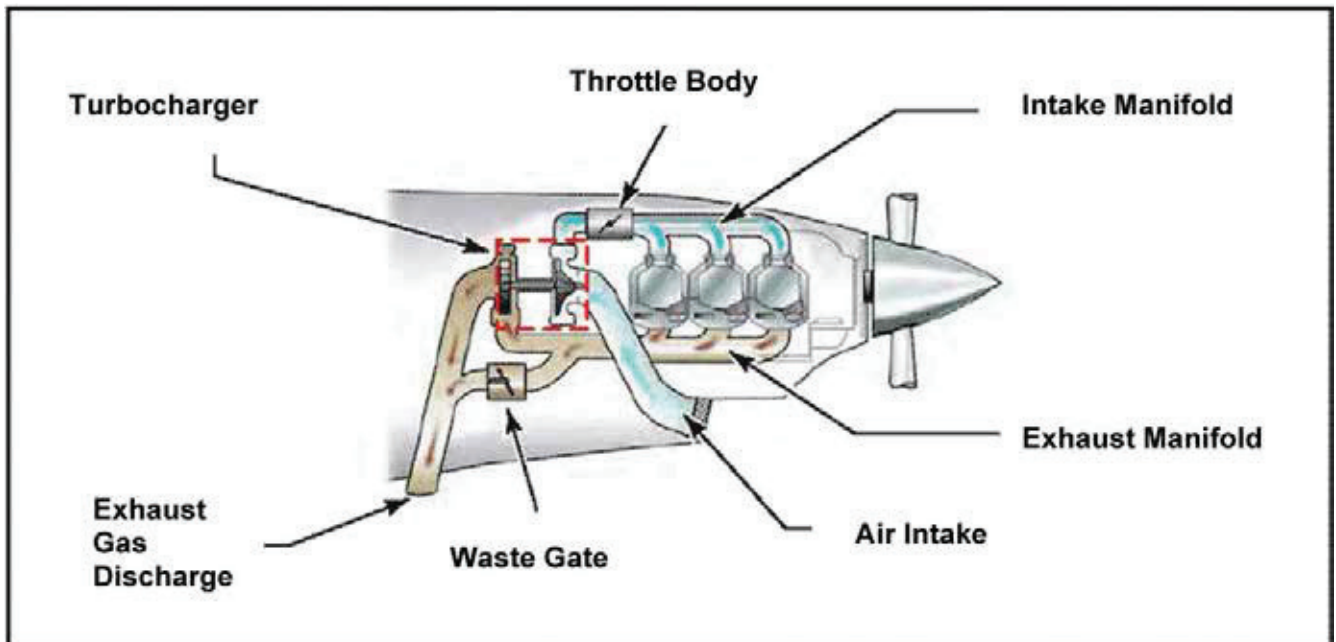

Figure C-1 Turbocharger Components

Note. From "Online Free Private Pilot Ground School", *The Aircraft Powerplant*. Retrieved March 17, 2009, from <http://www.free-online-private-pilot-ground-school.com/aircraft-powerplant.html>

2. Explain the key differences between turbocharging and supercharging.

A turbocharger compresses the intake air using a turbine turned by the exhaust gases.

A supercharger compresses the intake air using a turbine turned by the engine / crankshaft power.

3. Place the following labels in the correct location:

- a. supercharger,
- b. intake manifold,
- c. airscoop,
- d. intake valve,
- e. carburetor, and
- f. throttle.

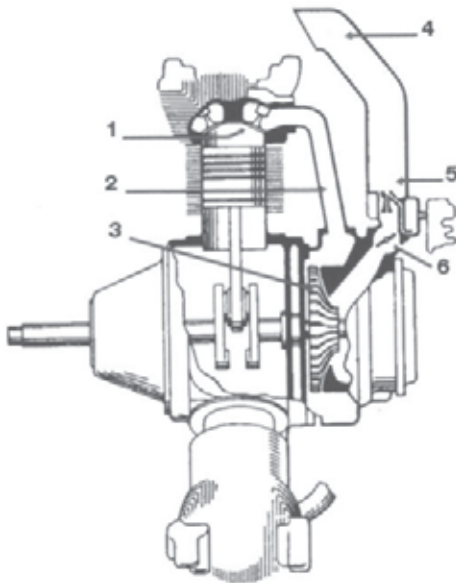

1. **intake valve**

2. **intake manifold**

3. **supercharger**

4. **airscoop**

5. **carburetor**

6. **throttle**

Figure C-2 Supercharger Components

Note. From *From the Ground Up: Millennium Edition* (p. 56), by A. F. MacDonald and I. L. Pepper, 2000, Ottawa, ON: Aviation Publishers Co. Limited. Copyright 2000 by Aviation Publishers Co. Limited.



**ROYAL CANADIAN AIR CADETS
PROFICIENCY LEVEL FOUR
INSTRUCTIONAL GUIDE**



SECTION 6

EO C432.03 – DESCRIBE GAS TURBINE ENGINES

Total Time:	30 min
-------------	--------

PREPARATION

PRE-LESSON INSTRUCTIONS

Resources needed for the delivery of this lesson are listed in the lesson specification located in A-CR-CCP-804/PG-001, *Proficiency Level Four Qualification Standard and Plan*, Chapter 4. Specific uses for said resources are identified throughout the instructional guide within the TP for which they are required.

Review the lesson content and become familiar with the material prior to delivering the lesson.

Prepare slides located at Attachment A.

PRE-LESSON ASSIGNMENT

Nil.

APPROACH

An interactive lecture was chosen for this lesson to clarify, emphasize, and summarize gas turbine engines.

INTRODUCTION

REVIEW

Nil.

OBJECTIVES

By the end of this lesson the cadet shall have described gas turbine engines.

IMPORTANCE

It is important for cadets to be able to describe gas turbine engines as a solid understanding of gas turbine engines provides knowledge for potential instructional duties and is part of the fundamentals that cadets pursuing future aviation training will require.

Teaching Point 1**Describe turbojets.**

Time: 10 min

Method: Interactive Lecture

TURBOJETS

Newton's third law states that for every action there is an equal and opposite reaction. All propulsion systems rely on this fact in some way. A turbojet engine is a reactive engine, which creates thrust by ejecting hot gases to create a force, as described by Newton's third law of motion.

The amount of thrust developed by ejecting hot gases depends on the mass and velocity of the material ejected. A turbojet generates thrust by imparting a relatively large acceleration to a relatively small mass of air.



Show the slide of Figure A-1 to the cadets.

Air is brought into the engine through the intake opening at the front and compressed by a series of compressor blades. Once compressed, fuel is added and the mixture is ignited. The hot gases created by the very rapidly burning fuel / air mixture are highly pressurized. These high pressure gases exit at a high velocity out of the back of the engine. Between the combustion chamber and the exhaust nozzle, the high pressure gases are used to turn a turbine that is connected to the compressor blades.



In a reciprocating engine (eg, radial, in-line, horizontally opposed), a new combustion process occurs during each stroke / cycle.

In a turbojet engine, the combustion process is continuous from the time the engine is started until the engine is shut down.

To start the engine, pressurized air is injected into the engine from either an on-board or ground-based source. Another way is to use an alternate power source to spin the compressor blades, drawing air into the engine. Once a sufficient volume of air is flowing into the combustion chamber, fuel and an ignition source can be added. Once combustion has started and the hot exhaust gases are spinning the turbine connected to the compressor blades, the engine is capable of drawing air into itself on its own, and the on-board or ground-based air / power source can be disconnected.



As an aircraft with a turbojet engine flies faster, more air is pushed into the engine as a result of the forward motion. This improves the fuel efficiency of the engine. A turbojet engine becomes more fuel efficient as the airspeed increases.

Conversely, turbojets become fuel inefficient at low airspeeds.

Turbojets can usually be identified visually by their external shape. Turbojets typically have a constant diameter from the front of the engine (air intake) to the rear of the engine (exhaust nozzle).

CONFIRMATION OF TEACHING POINT 1

QUESTIONS:

- Q1. Which law of motion does a turbojet engine demonstrate?
- Q2. What is different about the combustion in a turbojet engine, when compared to a reciprocating engine?
- Q3. What happens to the fuel efficiency of a turbojet engine as the airspeed increases?

ANTICIPATED ANSWERS:

- A1. A turbojet engine demonstrates Newton's third law of motion.
- A2. In a turbojet engine, the combustion process is continuous from the time the engine is started until the engine is shut down.
- A3. A turbojet engine becomes more fuel efficient as the airspeed increases.

Teaching Point 2

Describe turbofans.

Time: 10 min

Method: Interactive Lecture

TURBOFANS



Show the slide of Figure A-2 to the cadets.

The turbofan is a turbojet with a fan attached in front of the compressor blades. The fan diameter is larger than the engine core and some of the air moved by the fan bypasses the engine core. This air is moved backwards by the fan in the same way that a propeller works and creates additional thrust for the engine.

In a low-bypass turbofan, the amount of air that bypasses the engine and the amount of air that enters the engine core are approximately equal. In a high-bypass turbo fan, approximately four times as much air may bypass the engine core, which may result in up to 80 percent of the total thrust coming from the bypass portion of the engine.



Show the slide of Figure A-3 to the cadets.



Turbofans are more fuel efficient than turbojets, especially at lower airspeeds. They also produce less noise than turbojets. A turbofan produces more thrust than a turbojet of a similar physical size.

Turbofans can usually be identified visually by their external shape. Turbofans typically have an air intake that is two to four times the diameter of the exhaust nozzle.

Additional advantages of a turbofan engine include:

- very high power to weight ratio, compared to reciprocating and turbojet engines; and
- less vibration than a reciprocating engine.

Disadvantages of a turbofan engine include:

- high cost, and
- delayed response to changes in power settings.

CONFIRMATION OF TEACHING POINT 2

QUESTIONS:

- Q1. What is a turbofan engine?
- Q2. How much air may bypass the engine core in a high-bypass turbofan engine?
- Q3. What are two advantages of a turbofan engine?

ANTICIPATED ANSWERS:

- A1. A turbofan is a turbojet with a fan attached in front of the compressor blades.
- A2. In a high-bypass turbofan approximately four times as much air that enters the engine core may bypass the engine core.
- A3. Two advantages of a turbofan engine include:
- very high power to weight ratio, compared to reciprocating and turbojet engines; and
 - less vibration than a reciprocating engine.

Teaching Point 3

Describe turboprops and turboshafts.

Time: 5 min

Method: Interactive Lecture

Instead of using the power of the exhaust gases to produce thrust directly, the gases can be used to turn a turbine connected to a propeller or a shaft.

TURBOPROPS



Show the slide of Figure A-4 to the cadets.

When the power of the exhaust gases are used to turn a propeller, the engine is called a turboprop. In a fixed shaft turboprop, the same turbine turns both the compressor blades and the shaft connected to the propeller. In a free turbine turboprop, a separate turbine is used to turn the shaft connected to the propeller.



The PT6 turboprop engine, manufactured by Pratt and Whitney Aircraft of Canada, is one of the most popular turboprop engines in the world. It comes in a variety of power outputs and is used in a wide range of aircraft.



In all turboprop engines, the shaft from the turbine is connected to a gearbox to reduce the speed of the shaft to a range that is suitable for spinning the propeller.

TURBOSHAFTS

If the shaft of the gas turbine engine is connected to something other than a propeller, the engine is called a turboshaft. The shaft will be connected to a transmission system, and may be used to drive helicopter rotors, electrical generators, compressors, pumps, marine propulsion systems (eg, ships), and / or land propulsion systems (eg, tanks).

CONFIRMATION OF TEACHING POINT 3

QUESTIONS:

- Q1. What is the difference between a turboprop and a turboshaft engine?
- Q2. What is the shaft connected to in a turboprop engine to reduce the speed of the shaft?
- Q3. For what can a turboshaft engine be used?

ANTICIPATED ANSWERS:

- A1. In a turboprop engine, the shaft is connected to a propeller; in a turboshaft engine, it is connected to something other than a propeller.
- A2. In a turboprop engine, the shaft from the turbine is connected to a gearbox to reduce the speed of the shaft to a range that is suitable for spinning the propeller.
- A3. A turboshaft engine may be used for:
 - helicopter rotors,
 - electrical generators,
 - compressors,
 - pumps,
 - marine propulsion systems (eg, ships), and / or
 - land propulsion systems (eg, tanks).

END OF LESSON CONFIRMATION

QUESTIONS:

- Q1. How does a turbojet generate thrust?
- Q2. How can a turbofan be visually identified?
- Q3. How is a free turbine turboprop different from a fixed shaft turboprop?

ANTICIPATED ANSWERS:

- A1. A turbojet generates thrust by imparting a relatively large acceleration to a relatively small mass of air.
- A2. Turbofans typically have an air intake that is two to four times the diameter of the exhaust nozzle.
- A3. In a free turbine turboprop, a separate turbine is used to turn the shaft connected to the propeller. In a fixed shaft turboprop, the same turbine turns both the compressor blades and the shaft connected to the propeller.

CONCLUSION

HOMEWORK / READING / PRACTICE

Nil.

METHOD OF EVALUATION

Nil.

CLOSING STATEMENT

Being able to describe gas turbine engines is important for understanding more complex material. A solid understanding of gas turbine engines is required to pursue future aviation training and provides knowledge for potential instructional duties.

INSTRUCTOR NOTES / REMARKS

Nil.

REFERENCES

C3-116 ISBN 0-9680390-5-7 MacDonald, A. F., & Pepler, I. L. (2000). *From the ground up: Millennium edition*. Ottawa, ON: Aviation Publishers Co. Limited.

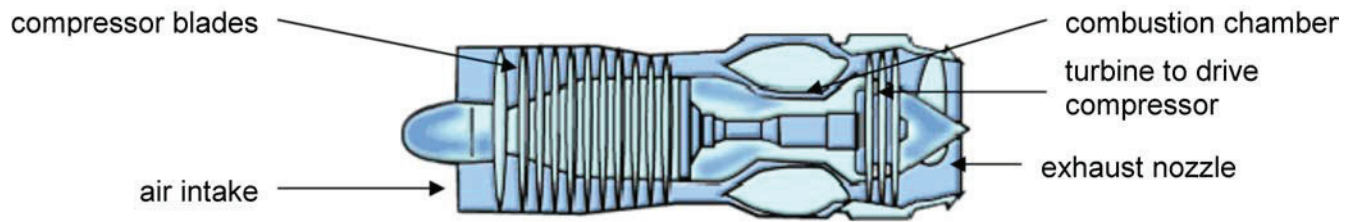

Figure A-1 Turbojet Engine

Note. From "Engines", *NASA Ultra Efficient Engine Technology*. Retrieved March 19, 2009, from <http://www.ueet.nasa.gov/StudentSite/engines.html>

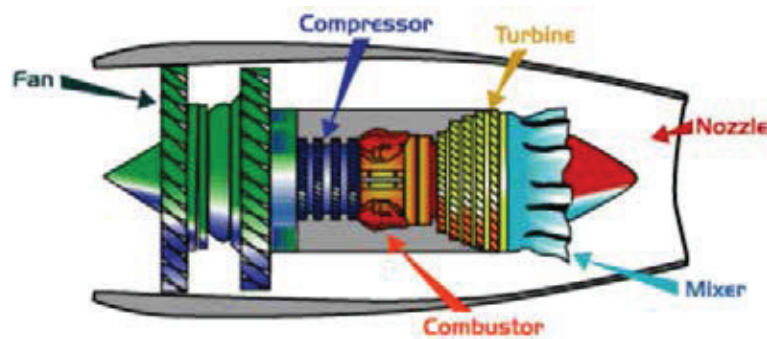

Figure A-2 Turbofan Engine

Note. From "Engines", *NASA Ultra Efficient Engine Technology*. Retrieved March 19, 2009, from <http://www.ueet.nasa.gov/StudentSite/engines.html>

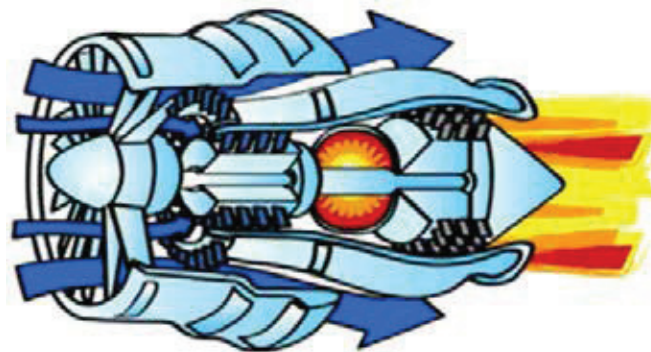

Figure A-3 Airflow Through a Turbofan Engine

Note. From "Engines", *NASA Ultra Efficient Engine Technology*. Retrieved March 19, 2009, from <http://www.ueet.nasa.gov/StudentSite/engines.html>

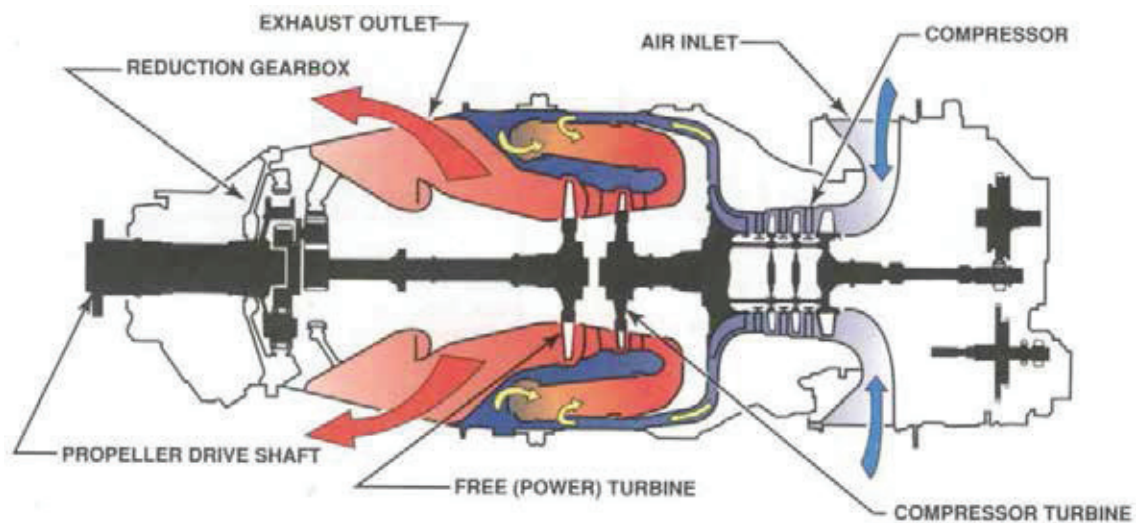

Figure A-4 Free Turbine Turboprop Engine

Note. From *A&P Technician Powerplant* (p. 3-6), by Jeppesen Standard Training Products, 2000, Englewood, CO:Jeppesen Sanderson Training Systems.